

# pipetman<sup>®</sup>

L

## User's Guide

EN



Variable volume single and multichannel models and fixed volume models

 **GILSON<sup>®</sup>**



# TABLE OF CONTENTS

## **INTRODUCTION | 3**

Parts Checklist | 3

GLP Features | 3

Description | 4

Specifications | 5

## **SETTING THE VOLUME (Variable Volume Models Only) | 7**

## **USER ADJUSTMENTS (Fixed Models Only) | 7**

### **PIPETTING | 8**

Fit the Tips | 8

Pre-Rinse the Tips | 9

Aspirate | 10

Dispense | 10

Eject the Tips | 10

Guidelines for Good Pipetting | 10

### **ACCESSORIES | 11**

### **TROUBLESHOOTING | 12**

Troubleshooting Table | 12

Leak Test | 13

### **MAINTENANCE FOR SINGLE AND FIXED MODELS | 14**

Change the Tip Ejector | 14

Change the Tip Holder | 14

Service the Piston Assembly | 15

Change the Seals | 16

### **MAINTENANCE FOR MULTICHANNEL MODELS | 16**

### **CLEANING AND DECONTAMINATION | 17**

Cleaning | 17

Autoclaving | 17

Chemical Decontamination | 18

### **SPARE PARTS | 19**

### **WARRANTY | 22**

#### **NOTICE**

Decreased pipetting forces are due to the design of the piston assembly, which includes a very high quality lubricant (part number 5440011070). The use of other lubricant cancels the warranty of your pipette.

# Chapter 1

## INTRODUCTION



PIPETMAN® L is an air displacement pipette and is used with disposable tips. To answer the current needs of intensive use of pipettes, and still being conform to Gilson brand qualities, improvements have been implemented to our mechanical series:

- Light and comfortable body, both for right and left handed.
- All forces necessary to pipetting task dramatically decreased\*.
- Full autoclavability for variable volume models.
- Lockable volume for variable volume models.
- 2D code for traceability.
- Name tag.
- For the single variable volume models: choice between a plastic ejector and a stainless steel ejector.

\* Implementation of new features to improve dramatically pipetting comfort has no impact on the legendary robustness, accuracy and precision of PIPETMAN.

8 single channel models cover a volume range from 0.2 µL to 10 mL.

15 fixed models cover a volume range from 1 µL to 5000 µL.

8 multichannel models cover a volume range from 0.5 µL to 300 µL.

### Parts Checklist

After unpacking the pipette, verify that the following items were included and are undamaged:

#### SINGLE MODELS

- PIPETMAN L,
- User's Guide,
- Safety bag,
- Certificate of conformity (including bar-code sticker).

#### MULTICHANNEL MODELS

- PIPETMAN L,
- User's Guide,
- Safety bag,
- Ejector spacer for D10 tips,
- Certificate of conformity (including bar-code sticker).

#### FIXED MODELS

- PIPETMAN L,
- User's Guide,
- Safety bag,
- Adjustment key,
- Certificate of conformity (including bar-code sticker).

### GLP Features

The Serial Number is engraved on the body of the pipette. It provides unique identification of your pipette and the date of manufacture. Example : GB58672

The Bar Code on the box and the certificate of conformity provide traceability of your pipette.

In addition a 2D code is engraved next the Serial number: this code includes the ordering reference, the end date, the serial number and the nominal volume. Example: FA10006 201103 GB58672 1000

If you are equipped of a reader, you can integrate this information in your own traceability system.

Ordering reference: 7 characters - Blank - Manufacturing date (year and month): 6 characters - Blank - Serial number: 7 characters - Blank - Nominal volume in µL: up to 5 characters



**Figure 1**  
Serial Number Location

## Description

Please refer to the following chapters for a full description of the different parts and functions of the pipette.

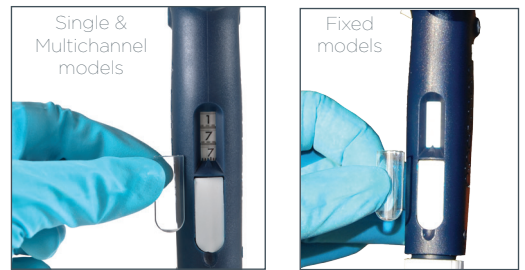

**Figure 2**  
PIPETMAN® single channel, multichannel, and fixed models

### Personal label

You can identify your pipette with a name tag:

1. Pry out the window by inserting a small screwdriver in the access slot.
2. Position the name tag in the slot.
3. Clip the window back into place.



**Figure 3**  
Label placement

## Specifications

PIPETMAN L is a high quality pipette that offers excellent accuracy and precision. The figures given in the “Gilson Maximum Permissible Errors” table were obtained using PIPETMAN DIAMOND Tips. These figures are guaranteed only when genuine PIPETMAN DIAMOND Tips are used.

Each pipette is inspected and validated by qualified technicians in accordance with the Gilson Quality System. Gilson declares that its manufactured pipettes comply with the requirements of the ISO 8655 standard, by type testing.

The adjustment is carried out under strictly defined and monitored conditions (ISO 8655-6).

### MAXIMUM PERMISSIBLE ERRORS

VARIABLE VOLUME MODELS				
VOLUME (µL)	GILSON		ISO 8655	
	SYSTEMATIC ERROR	RANDOM ERROR	SYSTEMATIC ERROR	RANDOM ERROR
<b>SINGLE CHANNEL PIPETTES</b>				
<b>P2L (P/N FA10001P OR FA10001M)</b>				
Min	0.2	±0.024	≤0.012	±0.08
	0.5	±0.025	≤0.012	±0.08
	1	±0.027	≤0.013	±0.08
Max	2	±0.030	≤0.014	±0.08
<b>P10L (P/N FA10002P OR FA10002M)</b>				
Min	1	±0.025	≤0.012	±0.12
	5	±0.075	≤0.030	±0.12
Max	10	±0.100	≤0.040	±0.12
<b>P20L (P/N FA10003P OR FA10003M)</b>				
Min	2	±0.10	≤0.03	±0.20
	10	±0.10	≤0.05	±0.20
Max	20	±0.20	≤0.06	±0.20
<b>P100L (P/N FA10004P OR FA10004M)</b>				
Min	10	±0.35	≤0.10	±0.80
	50	±0.40	≤0.12	±0.80
Max	100	±0.80	≤0.15	±0.80
<b>P200L (P/N FA10005P OR FA10005M)</b>				
Min	20	±0.50	≤0.20	±1.60
	100	±0.80	≤0.25	±1.60
Max	200	±1.60	≤0.30	±1.60
<b>P1000L (P/N FA10006P OR FA10006M)</b>				
Min	100	±3.0	≤0.6	±8.0
	500	±4.0	≤1.0	±8.0
Max	1000	±8.0	≤1.5	±8.0
<b>P5000L (P/N FA10007)</b>				
Min	500	±12	≤3	±40
	2500	±15	≤5	±40
Max	5000	±30	≤8	±40
<b>PIOML L (P/N FA10008)</b>				
Min	1000	±30	≤6	±60
	5000	±40	≤10	±60
Max	10000	±60	≤16	±60
<b>MULTICHANNEL PIPETTES</b>				
<b>P8X10L (P/N FA10013) AND P12X10L (P/N FA10014)</b>				
Min	0.5	±0.08	≤0.04	±0.24
	1	±0.08	≤0.05	±0.24
	5	±0.20	≤0.10	±0.24
Max	10	±0.20	≤0.10	±0.24
<b>P8X20L (P/N FA10009) AND P12X20L (P/N FA10010)</b>				
Min	2	±0.10	≤0.08	±0.40
	10	±0.20	≤0.10	±0.40
Max	20	±0.40	≤0.15	±0.40
<b>P8X200L (P/N FA10011) AND P12X200L (P/N FA10012)</b>				
Min	20	±0.50	≤0.25	±3.2
	100	±1.00	≤0.40	±3.2
Max	200	±2.00	≤0.50	±3.2
<b>P8X300L (P/N FA10015) AND P12X300L (P/N FA10016)</b>				
Min	20	±1.00	≤0.35	±8
	30	±1.00	≤0.35	±8
	150	±1.50	≤0.60	±8
Max	300	±3.00	≤1.00	±8





FIXED MODELS					
MODEL	VOL (μL)	GILSON		ISO 8655	
		SYSTEMATIC ERROR	RANDOM ERROR	SYSTEMATIC ERROR	RANDOM ERROR
F1L (FA10017)	1	±0.020	≤0.015	±0.05	≤0.05
F2L (FA10018)	2	±0.050	≤0.020	±0.08	≤0.04
F5L (FA10019)	5	±0.05	≤0.025	±0.125	≤0.075
F10L (FA10020)	10	±0.060	≤0.030	±0.12	≤0.08
F20L (FA10021)	20	±0.100	≤0.050	±0.2	≤0.1
F25L (FA10022)	25	±0.200	≤0.070	±0.5	≤0.2
F50L (FA10023)	50	±0.35	≤0.12	±0.5	≤0.2
F100L (FA10024)	100	±0.55	≤0.15	±0.8	≤0.3
F200L (FA10025)	200	±1.20	≤0.30	±1.6	≤0.6
F250L (FA10026)	250	±1.50	≤0.75	±4	≤1.5
F300L (FA10027)	300	±2.4	≤0.5	±4	≤1.5
F400L (FA10028)	400	±2.4	≤0.8	±4	≤1.5
F500L (FA10029)	500	±3.0	≤0.8	±4	≤1.5
F1000L (FA10030)	1000	±5.0	≤1.3	±8	≤3
F5000L (FA10031)	5000	±20.0	≤7.0	±40	≤15

**NOTICE**

The data given in the tables conform to the ISO 8655-2 Standard. With a precise pipetting technique (refer to [Guidelines for Good Pipetting](#), page 10) the P2L model may be used to aspirate volumes as low as 0.1 μL and the P10L model as low as 0.5 μL.

**NOTICE**

Each single pipette model (except P5000L and P10mL L) has two different part numbers to identify the kind of tip ejector required. For a pipette with a plastic tip ejector, the part number is ended by the letter P, for a pipette with a stainless steel tip ejector, the part number is ended by the letter M.

Ex: For a P10L model with the plastic tip ejector the part number is FA10002P. For the same pipette with a stainless steel tip ejector, the part number is FA10002M

## SETTING THE VOLUME

This section applies to variable volume models only.

The volume of liquid to be aspirated is set using the volumeter. The dials are colored either black or red to indicate the position of the decimal point, depending on the model (refer to Figure 4).

MODEL	COLOR OF VOLUMETER NUMBERS		
	BLACK	RED	INCREMENT
P2L	μL	0.01 μL	0.002 μL
P10L to P20L - Lx10	μL	0.1 μL	0.02 μL
P100L - P200L - Lx200 - Lx300	μL	—	0.2 μL
P1000L	0.01 mL	mL	0.002 mL
P5000L	0.01 mL	mL	0.002 mL
P10mL L	mL	0.1 mL	0.02 mL

### Lock System

For additional safety, the volume selected is lockable.

- 1 With the left or right thumb, unlock the thumbwheel by pushing it up.
- 2 The volume is set by turning the thumbwheel. The thumbwheel may be turned using only one hand to slowly reach the required setting.
- 3 Push down the thumbwheel; the new volume selected is locked.

To obtain maximum accuracy when setting the volume, proceed as follows:

- When **decreasing** the volume setting, slowly reach the required setting, making sure not to overshoot the mark.
- When **increasing** the volume setting, pass the required value by 1/3 of a turn and then slowly decrease to reach the volume, making sure not to overshoot the mark.

#### Multichannel models



7.5 μL 12.5 μL

#### Single channel models

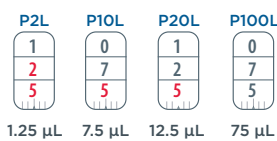

1.25 μL 7.5 μL 12.5 μL 75 μL

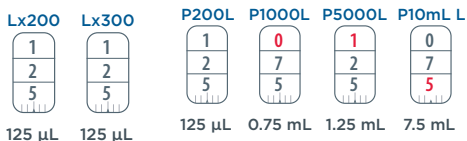

125 μL 125 μL 125 μL 0.75 mL 1.25 mL 7.5 mL

**Figure 4**

Dial Colors by Model



**Figure 5**

Volume unlock

#### NOTICE

Protection of your pipette and your work:

If step 3 is forgotten, the volume selected will be automatically locked during the next purge.

## USER ADJUSTMENTS

This section applies to Fixed models only.

PIPETMAN L Fixed is factory calibrated using distilled water and very high precision balances. The nominal value of the PIPETMAN L Fixed may be slightly adjusted to compensate for liquids of different density or viscosity.

To accommodate for density or viscosity, an adjustment with one full turn of the calibration key in either direction equals:

± 0.05 μL	(models F1L to F2L)
± 0.2 μL	(models F5L to F10L)
± 0.5 μL	(models F20L to F25L)
± 2.0 μL	(models F50L to F100L)
± 5.1 μL	(models F200L to F250L)
± 20 μL	(models F300L to F1000L)
102 μL	(model F5000L)

The cover is graduated in tenths of the key revolution (letters A, B,... J) and is read from left to right. Each small graduation mark represents 0.25 of the distance between each letter.

#### NOTICE

Adjustment of the factory calibration must only be performed using a special calibration key.

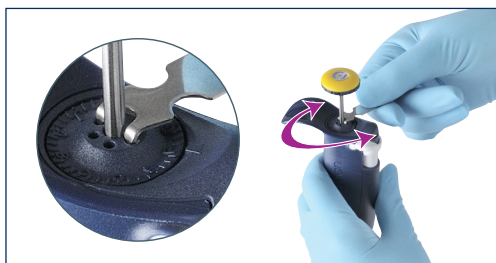

**Figure 6**

To adjust your PIPETMAN L Fixed, hold the key in the highest position to avoid banging it into the hook.





To adjust the volume setting to compensate for a specific density or viscosity, engage the two hooks of the spanner tool inside the two small holes on the top of the body, then turn the key slowly:

- **Clockwise** to decrease the volume; making sure not to overshoot the mark.
- **Counterclockwise** to increase the volume; pass the required value by 1/4 turn, then slowly decrease the volume to reach the required setting.

Example: When using a PIPETMAN L Fixed 100 to aspirate a particularly viscous solution, you may determine gravimetrically that the volume delivered is 98.8  $\mu\text{L}$ , and the display reads "H". Therefore, you wish to increase the volume dispensed by 1.2  $\mu\text{L}$ . As the interval between each letter on the calibration display represents 0.2  $\mu\text{L}$  for the F100L (1/10 of 2  $\mu\text{L}$ ), the calibration tool must be turned 3 units until the display reads "B".

It is possible to alter the volume by more than one full turn in the counterclockwise direction. In this case, remember to readjust the same number of turns when it is necessary to return to the original setting.

Check the new volume gravimetrically. If the volumes delivered are still not sufficiently close to the desired value, make another slight adjustment in the relevant direction. **Be sure to change tips between volume setting adjustments and to pre-rinse each new tip.**

When the PIPETMAN L Fixed is readjusted to compensate for a particular solution, the nature of the liquid can be noted on the labels inserted in the slot under the counter.

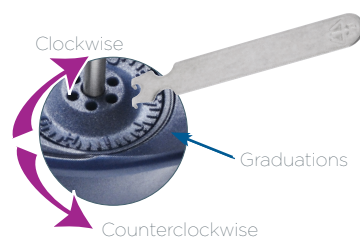

**Figure 7**  
Adjust PIPETMAN L Fixed volume setting to compensate for a specific density or viscosity



**Figure 8**  
Identify the liquid used with the label

**NOTICE** Liquids of high density, vapor pressure, or viscosity are best pipetted by the MICROMAN positive displacement pipette.

## Chapter 4 PIPETTING

It is recommended to use PIPETMAN® DIAMOND Tips with the PIPETMAN L for optimum performance. These tips are made from pure polypropylene. Plastic tips are for a single application—they must not be cleaned for reuse.

### Fit the Tips

#### SINGLE CHANNEL MODELS

To fit a new PIPETMAN DIAMOND tip, push the tip holder into the tip using a slight twisting motion to ensure a firm and airtight seal.

PIPETMAN DIAMOND Tip Compatibility for Single models	
P2L, P10L	D10, DL10, DF10, DFL10
P20L	D200, DF30
P100L	D200, DF100
P200L	D200, DF200, D300, DF300
P1000L	D1000, D1200, DF1000, DF1200
P5000L	D5000
P10mL L	D10mL

PIPETMAN DIAMOND Tip Compatibility for Fixed models	
F1L, F2L, F5L, F10L	D10, DL10, DF10, DFL10
F20L, F25L	D200, DF30
F50L, F100L	D200, DF100
F200L	D200, DF200
F250L	D300, DF300
F300L, F400L, F500L, F1000L	D1000, DF1000
F5000	D5000

**Figure 9**  
PIPETMAN DIAMOND Tip compatibility charts

**For the P2L and P10L models equipped with a stainless steel tip ejector, a dual-position adapter (plastic) is required to fit DL10 tips (long tips) or D10 tips (short tips). The metallic rod of the tip ejector is shaped so that the adapter may be clipped to it in either of two positions.**



P2L and P10L models are delivered with the adapter in place, positioned in the longer slot, and ready to use DL10 tips. When D10 tips (which are shorter) are used, the adapter must be repositioned in the shorter slot as follows:

1. Pull the adapter down from the stainless steel tip ejector.
2. Turn the adapter 180°.
3. Refit the adapter so that the end of the stainless steel tip ejector engages the shorter slot of the adapter.

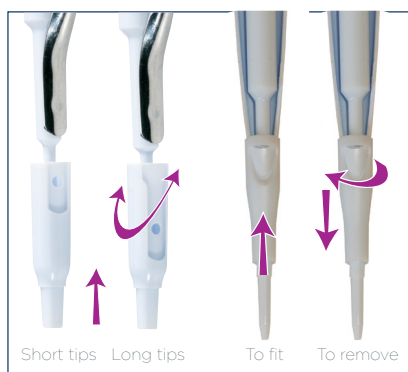

**Figure 10**  
Tip ejector extension for P2L and P10L

**For the F1L, F2L, F5L, F10L, P2L, and P10L models equipped with a plastic tip ejector,** a tip ejector extension is supplied to fit with D10 tips (short tips).

**To fit a tip ejector extension:**

1. Slide the extension over the tip holder.
2. Push the extension firmly onto the end of the tip ejector until it clicks into place.

**To remove a tip ejector extension:**

1. Gently twist the extension
2. Pull it away from the pipette.

**NOTICE** Both dual-position adapter and tip ejector extension are autoclavable.

## MULTICHANNEL MODELS

### PIPETMAN DIAMOND Tip: Tipack™ and Towerpack™ – Rocky Rack™

PIPETMAN DIAMOND Tips are best fitted from the patented Rocky Rack available only in our Tipacks and Towerpacks.

PIPETMAN DIAMOND Tip Compatibility for Multichannel models	
P8x10L, P12x10L	D10*, DL10, DF10, DFL10
P8x20L, P12x20L	DL10, DFL10, DF30, D200
P8x200L, P12x200L	D200, D300, DF200, DF300
P8x300L, P12x300L	D200, D300, DF200, DF300

\* Thanks to the new ejector spacer, you can adapt a D10 tip (see below)



**Figure 11**  
The patented ROCKYRACK system available on TOWER-PACK and TIPACK makes it extremely easy to fit tips on a multichannel pipette.

**Figure 12**  
PIPETMAN DIAMOND Tip compatibility charts for multichannel models pipette.

### Ejector spacer for PIPETMAN L Multichannel 10 µL

According to the tip used, D10 or DL10, you might have to exchange the ejector spacer; the broad one is dedicated to D10, and the small one is dedicated to DL10:

- Remove the tip ejector, keep both ejector locks depressed; pull the tip ejector down.
- Gently press the tabs from the ejector spacer, and remove it from the tip ejector.
- Insert the alternative ejector spacer and click it to the tip ejector.
- To refit the tip ejector, gently re-insert the tip ejector vertically into the rails of the ejector support.



**Figure 13**  
Ejector spacer location

## Pre-Rinse the Tips

Some liquids (e.g., protein-containing solutions and organic solvents) can leave a film of liquid on the inside wall of the tip; pre-rinse the tip to minimize any errors that may be related to this phenomenon.

Pre-rinsing consists of aspirating the first volume of liquid and then dispensing it to waste. Tips will not fall off nor will they have to be manually positioned.

Subsequent volumes that you pipette will have levels of accuracy and precision within specifications.



## Aspirate

1. Press the push button to the **first stop** (this corresponds to the set volume of liquid).
2. Hold the pipette vertically and immerse the tip in the liquid (see immersion depth table below). Release the push button slowly and smoothly (to top position) to aspirate the set volume of liquid. Wait one second (time depends on model, see table below) ; then withdraw the pipette tip from the liquid. You may wipe any droplets away from the outside of the tip using a medical wipe, however if you do so take care to avoid touching the tip's orifice.

For the multichannel models, use a Gilson Reagent Reservoir (Refer to **ACCESSORIES** on page 11).

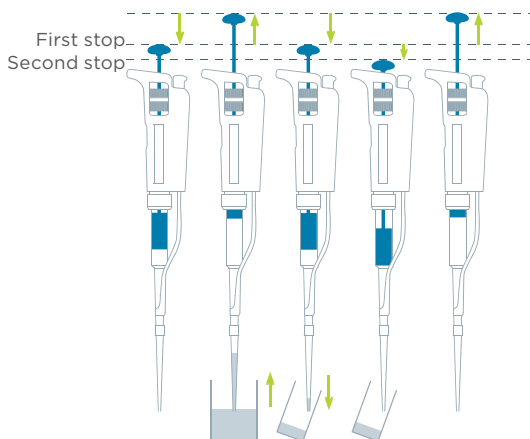

**Figure 14**  
Pipetting Motion - Aspirate and Dispense

## Dispense

1. Place the end of the tip against the inside wall of the recipient vessel (at an angle of 10° to 40°).
2. Press the push button slowly and smoothly to the **first stop**.
3. Wait for at least a second, then press the push button to the **second stop** to expel any residual liquid from the tip. Keep the push button pressed fully down and (while removing the pipette) draw the tip along the inside surface of the vessel.
4. Release the push button, smoothly. Eject the tip by pressing firmly on the tip ejector button.

For the multichannel models, use a Gilson reagent reservoir (refer to **ACCESSORIES** on page 11).

## Eject the Tips

Before you start to pipette, you can adjust the tip ejector button according to your preferences.

1. Position the tip ejector button. Simply rotate the tip ejector button to the most comfortable position: left, right, or middle.
2. Activate the tip ejector. You can either push the tip ejector button with the tip of the thumb as usual, or with the base of your thumb for more comfort. Please note the P5000L and P10mL L are not equipped with a tip ejector.



**Figure 15**  
Adjustable tip ejector button positions.

## Guidelines for Good Pipetting

1. Make sure that you operate the push button slowly and smoothly.
2. When aspirating, keep the tip at a constant depth below the surface of the liquid (refer to the table).

MODEL	IMMERSION DEPTH (MILLIMETERS)	WAIT TIME (SECONDS)
P2L, P10L, P8x10L, P12x10L, F1L, F2L, F5L, F10L	1	1
P20L, P8x20L, P12x20L, P8x200L, P12x200L, F20L, F25L	2-3	1
P100L, P200L, P8x300L, P12x300L, F50L, F100L, F200L, F250L	2-4	1
P1000L, F300L, F400L, F500L, F1000L	2-4	2-3
P5000L	3-6	4-5
P10mL L	5-7	4-5
F5000L	3-6	1

**NOTICE**

PIPETMAN L should be held in the vertical position.

3. Change the tip before aspirating a different liquid, sample, or reagent.
4. Change the tip if a droplet remains at the end of the tip from the previous pipetting operation.
5. Each new tip should be pre-rinsed with the liquid to be pipetted.
6. Liquid should **never** enter the tip holder; to prevent this:
  - o press and release the push button slowly and smoothly,
  - o never turn the pipette upside down,
  - o never lay the pipette on its side when there is liquid in the tip.
7. If you use the same tip with a higher volume, pre-rinse the tip.
8. For volatile solvents you should saturate the air cushion in your pipette by aspirating and dispensing the solvent repeatedly before aspirating the sample.
9. When the temperature of the liquid is different from the ambient temperature, pre-rinse the tip several times before use.
10. You may remove the tip ejector (refer to **Change the Tip Ejector** on page 14) to aspirate from very narrow tubes.
11. After pipetting acids or other corrosive liquids that emit vapors, remove the tip ejector and tip holder, rinse with distilled water, dry, and lubricate the piston (refer to **MAINTENANCE** on page 14). For the P1000L model, use a specific tip holder equipped with a filter to increase the lifetime of the piston (refer to **ACCESSORIES** on page 11).
12. Do not pipette liquids with temperatures above 70°C or below 4°C. The pipette can be used between +4°C and +40°C but the specifications may vary according to the temperature (refer to the ISO 8655-2 standard for conditions of use).

## Chapter 5

# ACCESSORIES

To make pipetting more comfortable and more secure, Gilson has developed several accessories:

Pipette stands allow users to store pipettes vertically to avoid the possibility of liquid running back into the pipette.

DESCRIPTION	P/N
CARROUSEL™ pipette stand (7 pipettes)	F161401
TRIO™ stand (3 pipettes)	F161405
Universal multichannel stand*	F161417
Single™ pipette holder	F161406

\* Universal multichannel stand is for multichannel models only.

To identify or personalize your pipette, COLORIS™ clips are available:

DESCRIPTION	P/N
COLORIS™ clips (mixed colors set of 10)	F161301
COLORIS clips (red, set of 10)	F161302
COLORIS clips (yellow, set of 10)	F161303
COLORIS clips (green, set of 10)	F161304
COLORIS clips (blue, set of 10)	F161305
COLORIS clips (white, set of 10)	F161306

With The JIMMY™, a hands-free microtube opener, you can open both snap-cap and screw-cap microtubes.

DESCRIPTION	P/N
The JIMMY™ (set of 3)	F144983

To protect the piston when pipetting corrosive liquids, you can use a specific tip holder and filter for the model P1000L:

DESCRIPTION	P/N
Corrosion Protection Kit (tip holder + a bag of 10 filters)	F144570
Corrosion Protection Kit Filter (Bag of 10)	F144571
Corrosion Protection Kit Filter (Bag of 50)	F144572

Disposable Reagent Reservoirs are ideal for dispensing reagent with multichannel pipettes:

DESCRIPTION	P/N
REAGENT RESERVOIR 25 mL, x100	F267660
REAGENT RESERVOIR 50 mL, x100	F267670



Universal Multichannel Stand™



COLORIS™



Corrosion protection kit





# TROUBLESHOOTING

A quick inspection of the pipette may help you to detect a potential problem.

**NOTE**

You may download the *2 Minute Inspection Poster* from the Gilson website ([www.gilson.com](http://www.gilson.com)), which shows how to perform a quick diagnosis of your pipette.

**WARNING**

Before returning any pipette to your local Gilson Service Center, ensure that it is completely free of chemical, biological, or radioactive contamination. Refer to [CLEANING AND DECONTAMINATION](#) on page 17. Please use the included safety bag to return the pipette to your local Gilson Service Center.

## Troubleshooting Table

The following table may help you to identify and correct the potential problem you might encounter.

### For single channel variable and fixed volume models

SYMPTOM	POSSIBLE CAUSE	ACTION
Pipette is leaking sample	Damaged tip holder	Replace the tip holder
	Worn O-ring or seal	Replace both parts and lubricate
Pipette won't aspirate	Worn O-ring	Replace both parts and lubricate
	Damaged tip holder	Replace the tip holder
	Connecting nut is loose	Tighten connecting nut
	Damaged or corroded piston	Return pipette to supplier
	Improper repair or assembly	Refer to page 14 - <a href="#">MAINTENANCE</a>
Pipette is inaccurate	Improper repair or assembly	Refer to page 14 - <a href="#">MAINTENANCE</a>
	Unscrew tip holder	Tighten connecting nut
	Connecting nut is loose	Tighten connecting nut
Pipette is not precise	Tip holder is loose	Tighten connecting nut
	Connecting nut is loose	Tighten connecting nut
	Incorrect operator technique	Operator training
	Damaged or corroded piston(s)	Return pipette to supplier
	Damaged tip holder(s)	Replace the tip holder(s)
Tips fall off or do not fit correctly	Worn O-ring or seal	Replace both parts and lubricate
	Low quality tips	Use PIPETMAN DIAMOND tips
	Damaged tip holder(s)	Replace the tip holder(s)
	Damaged tip ejector	Replace the tip ejector
Pipetting seize up	Dirty tip holder	Clean the tip holder with isopropanol or ethanol
	The tip ejector is loose	Assemble the tip ejector properly
	The ejector lock is misaligned	Align the ejector lock
	Piston needs lubricant	Lubricate piston assembly

### For variable volume multichannel models

SYMPTOM	POSSIBLE CAUSE	ACTION
Tips fall off or do not fit correctly	Low quality tips	Use PIPETMAN DIAMOND tips
	Damaged tip ejector	Replace the tip ejector
	Damaged ejector spacer	Replace the ejector spacer
Pipette won't aspirate	Dirty tip holder(s)	Clean the tip holder(s) with isopropanol or ethanol
	Damaged tip holder	Contact your local Gilson authorized service center
Pipette is inaccurate	Connecting nut is loose	Tighten the connecting nut
Pipette is not precise	Connecting nut is loose	Tighten the connecting nut
	Incorrect operator technique	Operator training

## Leak Test

This test may be performed at any time to check that the pipette does not leak, especially after performing a maintenance or decontamination procedure. If a pipette fails this test, replace the O-ring and seal. After making sure that the pipette is correctly reassembled, repeat this test.

**For the P2L to P200L Single channel models, and the F1L to F250L Fixed models:**

1. Fit a PIPETMAN DIAMOND Tip.
2. For the **variable volume models**, set the pipette to the maximum volume given in the specifications, and pre-rinse.
3. Aspirate the set volume from a beaker of distilled water.
4. Maintain the pipette in the vertical position and wait for 20 seconds.
5. If a water droplet appears at the end of the tip there is a leak.
6. If you see no droplets, re-immers the tip below the surface of water.
7. The water level inside the tip should remain constant; if the level goes down there is a leak.

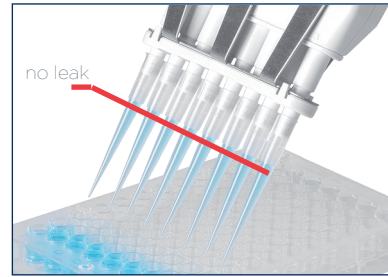

**Figure 16**  
PIPETMAN L multichannel leak test.

**For the P1000L, P5000L and P10mL L Single channel models, for the F300L to F5000L Fixed models:**

1. Fit a PIPETMAN DIAMOND tip.
2. For the **variable volume models**, set the pipette to the maximum volume given in the specifications.
3. Aspirate the set volume from a beaker of distilled water.
4. Maintain the pipette in the vertical position and wait for 20 seconds.
5. If a water droplet appears at the end of the tip, there is a leak.

**For the Multichannel models (8x - 12x):**

1. Fit the PIPETMAN DIAMOND tip.
2. Set the pipette to the maximum volume given in the specifications, and pre-rinse.
3. Aspirate the set volume from a reagent reservoir of distilled water.
4. Maintain the pipette in the vertical position and wait for 20 seconds ; fluid level in tips shoulds remain constant.
5. If a water droplet appears at the end of the tip, there is a leak.
6. If you see no droplets, for volumes below 200  $\mu$ L, re-immers the tip below the surface of water.
7. The water level inside the tip should remain constant; if the level goes down there is a leak.



# MAINTENANCE FOR SINGLE AND FIXED MODELS

Routine maintenance will help keep your pipette in good condition, ensuring a continued high level of performance.

Maintenance is limited to:

- Cleaning or decontamination (refer to [CLEANING AND DECONTAMINATION](#), page 17)
- Replacing spare parts
- Greasing the piston assembly.

PIPETMAN P2L and P10L, F1L, F2L, F5L and F10L should not be disassembled, so you may only replace the push button, tip ejector, dual position tip ejector and its adapter. With these pipettes if the tip holder is damaged, the piston may also be damaged.

## NOTICE

After replacing any parts you should verify the performance of your pipette following the verification procedure available on the Gilson website ([www.gilson.com](http://www.gilson.com)). If the pipette needs to be readjusted, please contact your local Gilson authorized Service Center.

## Change the Tip Ejector

### To remove

1. Push the ejection button.
2. Push laterally the tip ejector.
3. Slide and remove the tip ejector.

### To refit

1. Push the ejection button.
2. Slide the tip ejector along the tip holder.
3. Clip the tip ejector on the body of the pipette.

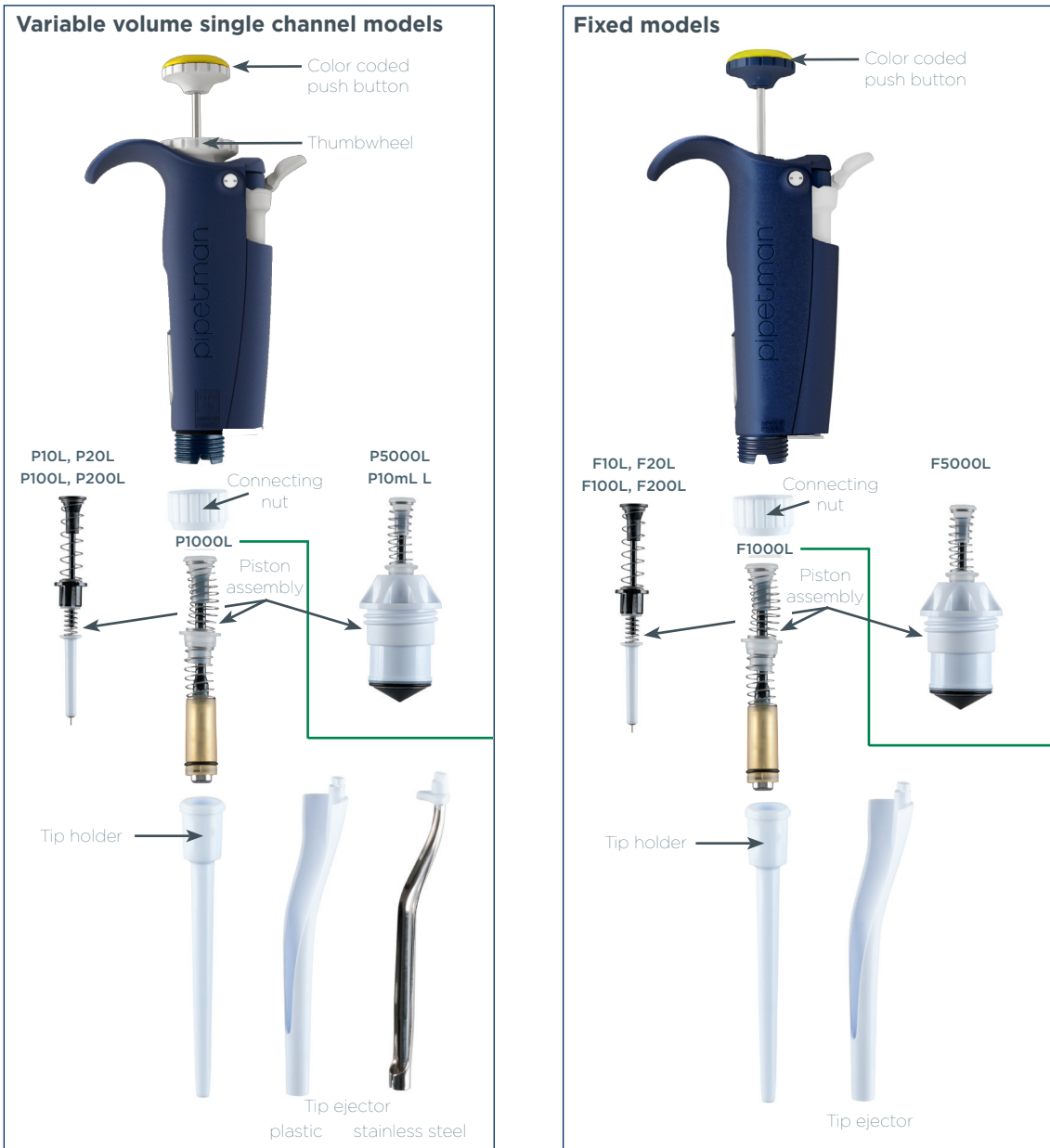

**Figure 17**  
Removing the tip ejector.

## Change the Tip Holder (no tools required)

1. Remove the tip ejector (refer to [Change the Tip Ejector](#)).
2. Unscrew the connecting nut by turning it clockwise.
3. Carefully separate the lower and upper parts.
4. Remove the piston assembly and the seals.
5. Clean, autoclave, or replace the tip holder.
6. If necessary, lubricate lightly the piston and its seals.
7. Reassemble the pipette (refer to figure 18 on page 15).
8. Tighten the connecting nut (turn counterclockwise).
9. Refit the tip ejector (see above).





**Figure 18**  
Piston Assembly (Disassembled)

## Service the Piston Assembly

You may remove the piston assembly for cleaning purposes only. If the piston assembly is changed, the pipette must be adjusted and calibrated in a Gilson-authorized Service Center. As the models P2L and P10L, F1L, F2L, F5L and F10L contain miniaturized parts, it is best not to disassemble these pipettes yourself.

1. Remove the tip ejector (refer to [Change the Tip Ejector](#), page 14).
2. Unscrew the connecting nut by turning it clockwise.
3. Carefully separate the lower and upper parts.
4. Remove the piston assembly, O-ring and seal.
5. Leave exposed the piston, clean it with isopropanol or ethanol and lubricate lightly.

**For P20L, P100L, P200L, F20L, F25L, F50L, F100L, F200L, F250L:** lubricate only the useful part of the piston (20 ±5 mm length) and the O-ring.

**For P1000L, F300L, F400L, F500L, and F1000L:** lubricate the piston.

**For P5000L, P10mL L, and F5000L:** disassemble the seals, lubricate their internal part and lubricate the piston. Do not lubricate the O-ring.

6. Reassemble the pipette (refer to figure 18).
7. Tighten the connecting nut (turn counter-clockwise).
8. Refit the tip ejector (refer to [Change the Tip Ejector](#), page 14).

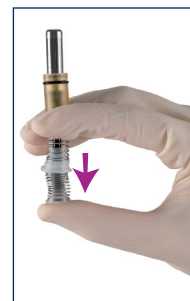

**Figure 19**  
Hold the piston assembly

## Change the Seals

The O-ring and seal are on the piston; if worn or damaged in any way (chemical or mechanical), they must be replaced. As the models P2L and P10L, F1L, F2L, F5L and F10L contain miniaturized parts, it is best not to disassemble these pipettes yourself, please contact your local Gilson-authorized Service Center.

The dimensions of the O-ring vary depending on the model of pipette.

1. Remove the tip ejector (refer to [Change the Tip Ejector](#), page 14).
2. Unscrew the connecting nut by turning it clockwise.
3. Carefully separate the lower and upper parts.
4. Remove the piston assembly, O-ring and seal.
5. If necessary clean the piston and replace the seal; lubricate them lightly. Please place them in the correct order.
6. Reassemble the pipette (refer to the figure 18, on page 15).
7. Tighten the connecting nut (turn counter-clockwise).
8. Refit the tip ejector (refer to [Change the Tip Ejector](#), page 14).

## Chapter 8

# MAINTENANCE FOR MULTICHANNEL MODELS

Routine maintenance will help keep your pipette in good condition, ensuring a continued high level of performance.

Maintenance is limited to:

- Cleaning or decontamination (refer to [CLEANING AND DECONTAMINATION](#), page 17)
- Replacing spare parts
- Greasing the piston assembly.

## Change the Tip Ejector

To remove the tip ejector, keep both ejector locks depressed. Pull the tip ejector down.

To refit the tip ejector, gently re-insert the tip ejector vertically into the rails of the ejector support. Pull lightly on the tip ejector to check the position.



**Figure 20**  
PIPETMAN L Multichannel tip ejector and ejector spacers





# CLEANING AND DECONTAMINATION



PIPETMAN L is designed so that the parts normally in contact with liquid contaminants, can easily be cleaned and decontaminated and the variable volume models are autoclavable without disassembly. However, because the models P2L and P10L, F1L, F2L, F5L, and F10L contain miniaturized parts, it is best not to disassemble these pipettes yourself; please contact your local Gilson authorized Service Center.

## NOTICE

You may refer to the decontamination procedure available on the Gilson website ([www.gilson.com](http://www.gilson.com)). Liquid must never enter the upper part (handle) of any pipette.

## Cleaning

The pipette must be cleaned, as described below, before it is decontaminated. Soap solution is recommended for cleaning PIPETMAN L.

### FOR VARIABLE VOLUME SINGLE AND FIXED MODELS

#### Cleaning External

1. Remove the tip ejector.
2. Wipe the tip ejector with a soft-cloth or lint-free tissue soaked with soap solution.
3. Wipe the entire pipette with a soft-cloth or lint-free tissue soaked with soap solution, to remove all dirty marks. If the pipette is very dirty, a brush with soft plastic bristles may be used.
4. Wipe the entire pipette and the tip ejector with a soft cloth or lint-free tissue soaked with distilled water.
5. Refit the tip ejector and allow the pipette to dry.

#### Cleaning Internal

The following components **only** can be immersed in a cleaning solution: connecting nut, tip ejector, tip holder, piston assembly, seal and O-ring.

1. Disassemble the pipette (refer to [MAINTENANCE FOR SINGLE AND FIXED MODELS](#), page 14).
2. Set aside the upper part in a clean, dry place.
3. Clean the individual components of the lower part of the pipette using an ultrasonic bath (20 minutes at 50°C) or with a soft-cloth and brushes. Note that the piston assembly and seals must be degreased with isopropanol or ethanol before being immersed in another ultra sonic bath. Small round brushes with soft plastic bristles may be used to clean the interior of the tip holder.
4. Rinse the individual components with distilled water.
5. Leave the parts to dry by evaporation or wipe them with a clean soft-cloth or lint-free tissue.
6. Reassemble the pipette (refer to [MAINTENANCE FOR SINGLE AND FIXED MODELS](#), page 14)

### FOR VARIABLE VOLUME MULTICHANNEL MODELS

The following components **only** can be immersed in a cleaning solution: tip ejector, ejector locks and ejector spacer.

1. Remove the tip ejector and the ejector spacer.
2. Immerse the tip ejector, ejector locks and ejector spacer in the cleaning solution or wipe them with a soft cloth or lint-free tissue soaked with the cleaning solution.
3. Rinse the components with distilled water.
4. Wipe the entire pipette with a soft cloth or lint-free tissue soaked with the cleaning solution.
5. Wipe it with distilled water.
6. Leave the parts to dry by evaporation or wipe them with a clean soft-cloth or lint-free tissue.
7. Refit the tip ejector (refer to [Change the Tip Ejector](#), page 16).

## Autoclaving

### FOR VARIABLE VOLUME (SINGLE AND MULTICHANNEL MODELS) ONLY

PIPETMAN L variable volume models are fully autoclavable without disassembly for maximum convenience as well as protection from contamination.

#### 1. Before autoclaving

It is possible to clean PIPETMAN L pipettes and grease the piston prior to autoclaving; however, if you remove existing grease, lightly lubricate the piston seal using only the grease specified in this User's Guide.

Set the pipette volume to the nominal volume before placing it in the autoclave.



## 2. Procedure

PIPETMAN L variable volume models can be sterilized by steam autoclaving at 121°C (252°F), 1 bar relative pressure for 20 minutes without disassembly.

When autoclaving, the pipette will dry better and faster without using a bag.

## 3. After autoclaving

Following the autoclaving cycle, leave the pipette to cool down to room temperature and dry completely before use.

Checking should be carried out according to your procedure.

### FOR FIXED MODELS

The upper part (body) and the piston assembly of the pipette are **not** autoclavable. **Only** the following parts may be autoclaved: tip ejector, tip holder and connecting nut.

## Chemical Decontamination

You may choose to decontaminate your pipette chemically, in accordance with your own procedures. Whatever decontaminant you use, check with the supplier of the decontaminant that it is compatible with stainless steel and the plastics used in the construction of the pipette: PA (Polyamide), PBT (Polybutylene Terephthalate), PC (Polycarbonate), PC/PBT (Polycarbonate/ Polybutylene Terephthalate), POM (Polyoxymethylene), PVDF (Polyvinylidene Fluoride), PP (Polypropylene), PPA (Polyphthalamide), or PPS (Polyphenylene Sulfide).

### FOR VARIABLE VOLUME SINGLE AND FIXED MODELS

#### Upper Part (Handle)

1. Wipe the upper part (handle) of the pipette with a soft-cloth or lint-free tissue soaked with the chosen decontaminant.
2. Wipe the upper part of the pipette with a soft- cloth or lint-free tissue soaked with distilled water or sterile water.

#### Lower Part (Volumetric module)

The following components **only** can be immersed in a decontaminant solution: connecting nut, tip ejector, tip holder.

Piston assembly and seals must be degreased with methyl alcohol before being immersed in decontamination solution in separate vessel.

1. Disassemble the pipette (refer to [MAINTENANCE FOR SINGLE AND FIXED MODELS](#), page 14).
2. Immerse tip ejector, tip holder and connecting nut in the cleaning solution.
3. Degrease the piston assembly, the seals and immerse them in another vessel.
4. Rinse each component with distilled water.
5. Leave the parts to dry by evaporation (or wipe with a soft cloth the tip ejector, the tip holder and connecting nut).
6. Lubricate the piston assembly and the seals.
7. Reassemble the piston assembly, the tip holder and the tip ejector.

### FOR VARIABLE VOLUME MULTICHANNEL MODELS

The following components only can be immersed in a decontamination solution: tip ejector, ejector locks and ejector spacer.

1. Remove the tip ejector and the ejector spacer.
2. Immerse the tip ejector, ejector locks and ejector spacer in the decontamination solution or wipe them with a soft-cloth or lint-free tissue soaked with the decontamination solution.
3. Rinse the components with distilled water.
4. Wipe the entire pipette with a soft cloth or lint-free tissue soaked with the decontamination solution.
5. Wipe it with distilled water.
6. Leave the parts to dry by evaporation or wipe them with a clean soft-cloth or lint-free tissue.
7. Refit the tip ejector (refer to [Change the Tip Ejector](#), page 16).

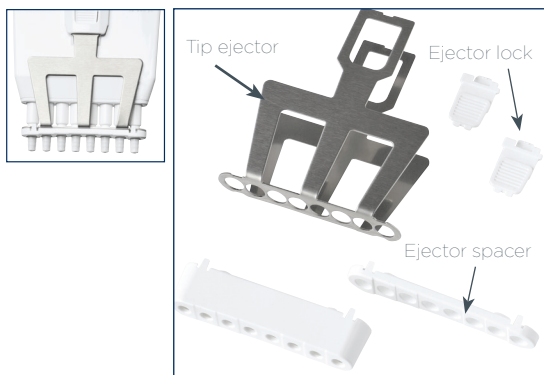

# Chapter 10

## SPARE PARTS



### For Variable Volume Single Models

- ▶ Service Kit 1<sup>st</sup> level includes:
  - Three piston seals or seal guides **C**
  - Three O-rings **D**
  - One tip holder **E**
- ▶ Service Kit 2<sup>nd</sup> level includes:
  - One push button **A**
  - One connecting nut **B**
  - One tip ejector **F1 F2**
- ▶ or only for the P2L and P10L models
  - One adapter for stainless steel tip ejector **F3**
  - One extension for plastic tip ejector **F4**

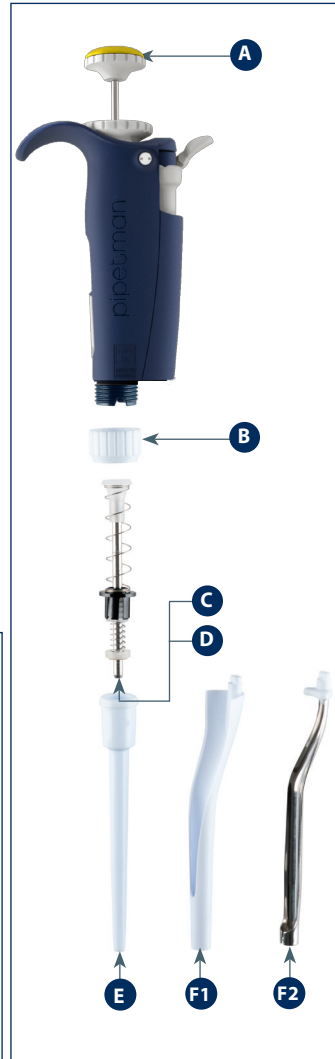

### P2L (FA10001P OR M) AND P10L (FA10002P OR M)

LABEL	DESCRIPTION	P2L	P10L
C+D+E	Service Kit 1 <sup>st</sup> level	F144501	FA07001
A+B+F1 to F4	Service Kit 2 <sup>nd</sup> level	FA07301	FA07302
C+D	Seal + O-Ring (5 sets)	F144861	FA07012
F3	Tip Ejector Adapter	F144879	F144879
F4	Tip Ejector Extension	F2070903	F2070903

### P20L (FA10003P OR M) AND P100L (FA10004P OR M)

LABEL	DESCRIPTION	P20L	P100L
C+D+E	Service Kit 1 <sup>st</sup> level	FA07002	FA07003
A+B+F	Service Kit 2 <sup>nd</sup> level	FA07303	FA07304
C+D	Seal guide + O-ring (5 sets)	FA07013	FA07014

### P200L (FA10005P OR M) AND P1000L (FA10006P OR M)

LABEL	DESCRIPTION	P200L	P1000L
C+D+E	Service Kit 1 <sup>st</sup> level	FA07004	FA07005
A+B+F	Service Kit 2 <sup>nd</sup> level	FA07305	FA07306
C+D	Seal guide + O-ring (5 sets)	FA07015	FA07016

### P5000L (FA10007) AND P10ML L (FA10008)

LABEL	DESCRIPTION	P5000L	P10ML L
C+D+E	Service Kit 1 <sup>st</sup> level	FA07311	FA07312
A	Service Kit 2 <sup>nd</sup> level	FA07019	FA07020
C+D	Seal guide + O-ring (5 sets)	FA07307	FA07308
E	Tip holder	F123608	F161263



### ALL MODELS

DESCRIPTION	PART NUMBER
Lubricant	5440011070

#### NOTE

Each Single pipette model (except P5000L and P10mL L) has two different ordering references to identify the kind of tip ejector required. For a pipette with a plastic tip ejector, the ordering reference is ended by the letter P, for a pipette with a stainless steel tip ejector, the ordering reference is ended by the letter M.

Ex: For a P10L model with the plastic tip ejector the ordering reference is FA10002P. For the same pipette with a stainless steel tip ejector, the ordering reference is FA10002M.



## For Variable Volume Multichannel Models

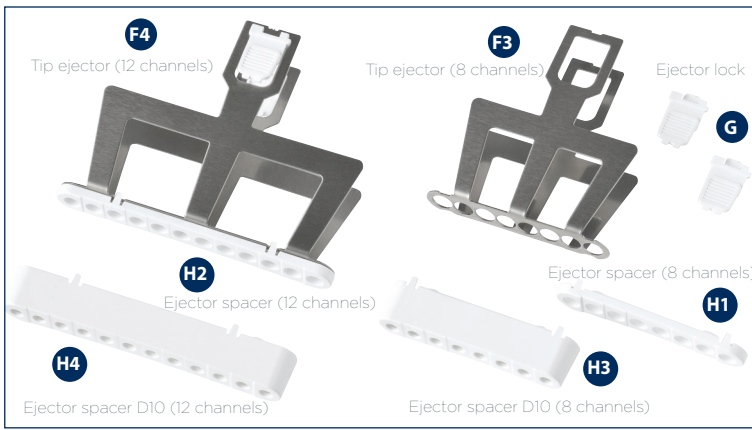

### P8X10L (FA10013) AND P12X10L (FA10014)

LABEL	DESCRIPTION	8X10	12X10
F3 - F4	Tip ejector	F507005	F507006
G	Ejector lock	F507008	F507008
H1 - H2	Ejector spacer	F507001	F507003
H3 - H4	Ejector spacer D10	F807114	F807115

### P8X20L (FA10009) AND P12X20L (FA10010)

LABEL	DESCRIPTION	8X20	12X20
F3 - F4	Tip ejector	F507005	F507006
G	Ejector lock	F507008	F507008
H1 - H2	Ejector spacer	F507001	F507003

### P8X200L (FA10011) AND P12X200L (FA10012)

LABEL	DESCRIPTION	8X200	12X200
F3 - F4	Tip ejector	F507005	F507006
G	Ejector lock	F507008	F507008
H1 - H2	Ejector spacer	F507001	F507003

### P8X300L (FA10015) AND P12X300L (FA10016)

LABEL	DESCRIPTION	8X300	12X300
F3 - F4	Tip ejector	F507005	F507006
G	Ejector lock	F507008	F507008
H1 - H2	Ejector spacer	F507001	F507003

## For Fixed Volumes Single Models

- ▶ Service Kit 1<sup>st</sup> level includes:
  - Three piston seals or seal guides **C**
  - Three O-rings **D**
  - One tip holder **E**
- ▶ Service Kit 2<sup>nd</sup> level includes:
  - One push button **A**
  - One connecting nut **B**
  - One tip ejector **F1 F2**
- ▶ or only for the F1L, F2L, F5L, and F10L models
  - One extension for plastic tip ejector **F4**

### F1L (FA10017), F2L (FA10018), F5L (FA10019), AND F10L (FA10020)

LABEL	DESCRIPTION	F1L/F2L	F5L/F10L
C+D+E	Service Kit 1 <sup>st</sup> level	F144501	FA07001
A+B+F1	Service Kit 2 <sup>nd</sup> level	FA07067	FA07068
C+D	Seal + O-Ring (5 sets)	F144861	FA07012
F4	Tip Ejector Extension	F2070903	F2070903

### F20L (FA10021), F25L (FA10022), F50L (FA10023), AND F100L (FA10024)

LABEL	DESCRIPTION	F20L/F25L	F50L F100L
C+D+E	Service Kit 1 <sup>st</sup> level	FA07002	FA07003
A+B+F1	Service Kit 2 <sup>nd</sup> level	FA07069	FA07070
C+D	Seal guide + O-ring (5 sets)	FA07013	FA07014

### F200L (FA10025) AND F250L (FA10026)

LABEL	DESCRIPTION	F200L	F250L
C+D+E	Service Kit 1 <sup>st</sup> level	FA07004	FA07004
A+B+F1	Service Kit 2 <sup>nd</sup> level	FA07071	FA07073
C+D	Seal guide + O-ring (5 sets)	FA07015	FA07015

### F300L (FA10027), F400L (FA10028), F500L (FA10029), F1000L (FA10030), AND F5000L (FA10031)

LABEL	DESCRIPTION	F300L F400L F500L F1000L	F5000L
C+D+E	Service Kit 1 <sup>st</sup> level	FA07005	FA07021
A+B+F1	Service Kit 2 <sup>nd</sup> level	FA07072	NA
C+D	Seal + O-ring (5 sets)	FA07016	FA07017

### ALL MODELS

DESCRIPTION	PART NUMBER
Lubricant	5440011070

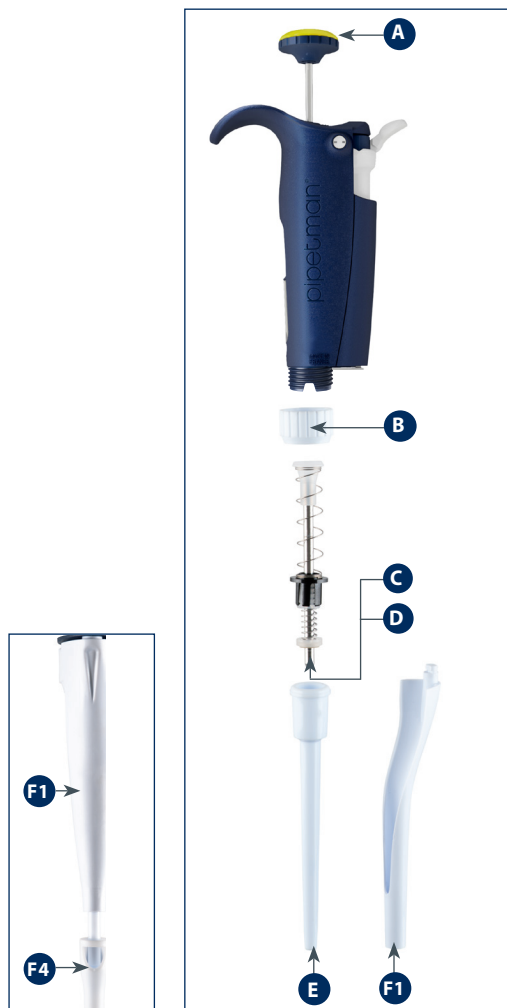

SPARE PARTS



## WARRANTY

Gilson warrants this pipette against defects in material under normal use and service for a period of 12 months from the date of purchase.

This warranty shall not apply to pipettes which are subject to abnormal use and/or improper or inadequate maintenance (contrary to the recommendations given in the user's guide), including, but not limited to pipettes which have been subjected to physical damage, improper handling, or spillage or exposure to any corrosive environment. This warranty shall also be void in the event pipettes are altered or modified by any party other than Gilson or its designates. Gilson's sole liability under this warranty shall be limited to, at Gilson's sole option, repair or replacement of any defective components of pipettes or refund of the purchase price paid for such pipettes.

**THE FOREGOING WARRANTY IS EXCLUSIVE AND GILSON HEREBY DISCLAIMS ALL OTHER WARRANTIES, WHETHER EXPRESS OR IMPLIED, INCLUDING ANY WARRANTIES OF MERCHANTABILITY AND ANY WARRANTIES OF FITNESS FOR A PARTICULAR PURPOSE, UNDER NO CIRCUMSTANCES SHALL GILSON BE LIABLE FOR ANY CONSEQUENTIAL, PUNITIVE, INDIRECT OR INCIDENTAL DAMAGES ARISING OUT OF ANY BREACH OF ANY EXPRESS OR IMPLIED WARRANTY.**



Specifications subject to change without notification — errors excepted.

[www.gilson.com/contactus](http://www.gilson.com/contactus)

**Gilson, Inc.**

3000 Parmenter Street • PO Box 620027  
Middleton, WI 53562 USA  
T: 608-836-1551 or 800-445-7661 • F 608-831-4451

**Gilson S.A.S.**

19, avenue des Entrepreneurs BP 145 • F-95400  
Villiers-le-Bel, France  
T +33 (0) 1 34 29 50 00 • F +33 (0) 1 34 29 50 20

LT801575/B | ©08/2017 Gilson, Inc. All rights reserved.

