

Register your instrument!
www.eppendorf.com/myeppendorf



Multipipette® E3/E3x Repeater® E3/E3x

Operating Manual

Copyright© 2022 Eppendorf SE, Germany. All rights reserved, including graphics and images. No part of this publication may be reproduced without the prior permission of the copyright owner.

Eppendorf® and the Eppendorf Brand Design are registered trademarks of Eppendorf SE, Germany.

Eppendorf trademarks and trademarks of third parties may appear in this manual. All trademarks are the property of their respective owners. The respective trademark name, representations and listed owners can be found here: www.eppendorf.com/ip. U.S. Patents and U.S. Design Patents are listed on www.eppendorf.com/ip.

Table of contents

1	Operating instructions	7
1.1	Using this manual	7
1.2	Danger symbols and danger levels	7
1.2.1	Danger symbols	7
1.2.2	Danger levels	7
1.3	Symbols used	7
1.4	Glossary	8
2	Safety	11
2.1	Intended use	11
2.2	Warnings for intended use	11
3	Product description	13
3.1	Delivery package	13
3.2	Features	13
3.3	Product overview	14
3.4	Layout of the display	15
3.5	Operating controls	16
3.6	Overview of the operating modes	16
3.7	Mains/power supply device and power plug adapter	17
3.8	Rechargeable battery charging status	17
3.9	Materials	18
3.10	Warranty	18
3.11	Overview of dispenser tips	19
3.11.1	Combitips advanced volume ranges	19
3.11.2	ViscoTip volume range	20
4	Installation	20
4.1	Preparing the dispenser for initial use	20
4.2	Mains/power supply device assembly	21
4.2.1	Identifying the mains/power supply device	22
4.2.2	Inserting the power plug adapter	22
4.2.3	Replace the power plug adapter	22
4.3	Connecting the rechargeable battery	23
5	Operation	24
5.1	Charging the rechargeable battery	24
5.1.1	Charging the rechargeable battery with the mains/power supply device	24
5.1.2	Charging the rechargeable battery in the charger stand or in the charger carousel	25
5.2	Preserving the battery capacity	26
5.2.1	Longer periods without operation – with charger stand	26
5.2.2	Longer periods without operation – without charger stand	26

Table of contents

4 Multipette® E3/E3x – Repeater® E3/E3x English (EN)

5.2.3	Replacing the rechargeable battery	26
5.3	Switching the dispenser on or off	26
5.4	Sets the operating mode	26
5.5	Dispenser tip	27
5.5.1	Inserting the dispenser tip	27
5.5.2	Ejecting the dispenser tip	28
5.6	Overview of parameters	28
5.6.1	Change Parameter	28
5.7	Aspirating liquid	29
5.8	Carrying out a reverse stroke	29
5.9	Pip operating mode – Pipetting of liquid	30
5.10	Dis operating mode – Dispensing of liquid	31
5.11	Ads operating mode – Automatic dispensing of liquid	32
5.12	Seq operating mode – Sequential dispensing of liquid	33
5.13	Asp operating mode – Multiple liquid aspiration	34
5.14	A/D operating mode – Aspiration and dispensing of liquid	35
5.15	Ttr operating mode – Titration of liquid	36
5.15.1	Displaying the data of the last titration	37
5.16	Renewed aspiration	37
5.17	Emptying the dispensing tip	38
5.18	Opt operating mode – Adjustment of device settings	38
5.18.1	Selecting a menu item	39
5.18.2	Changing an option	39
5.18.3	Activating/deactivating the Key lock option	40
5.18.4	Activating/deactivating the Favorites option	40
5.18.5	Activating/deactivating the Sound level option	40
5.18.6	Adjusting the Brightness option	41
5.18.7	Adjusting the Language option	41
5.18.8	Saving the Personalization option	42
5.18.9	Accessing the Service option	42
5.18.10	Performing the Self test service function	42
5.18.11	Setting the Reminder service function	42
5.18.12	Adjusting the Date and time option	43
5.18.13	Activating/deactivating the Screen saver option	43
5.19	Option of creating Favorites	43
5.19.1	Accessing Favorites	43
5.19.2	Editing Favorites	44
6	Troubleshooting	45
6.1	General errors	45
6.1.1	Dispenser	45
6.1.2	Rechargeable battery	45
6.1.3	Display	45
6.1.4	Dispenser tip – Combipips advanced	46

7	Maintenance	47
7.1	Service options	47
7.2	Cleaning	47
7.2.1	Cleaning and disinfecting the housing	47
7.3	Decontamination	48
7.4	Updating the software	48
8	Technical data	49
8.1	Adjustable sub-steps	49
8.2	Dispensing speeds	49
8.3	Dispenser	50
8.3.1	Rechargeable battery	50
8.3.2	Information on the battery life	50
8.3.3	Mains/power supply device	50
8.4	Errors of measurement	51
8.5	Ambient conditions	52
9	Transport, storage and disposal	53
9.1	Decontamination before shipment	53
9.2	Storage	54
9.3	Disposal	55
10	Ordering Information	56
10.1	Dispenser Multipette E3/E3x – Repeater E3/E3x	56
10.2	Spare parts	56
10.3	Accessories for the dispenser	56
10.4	Dispenser tip – Combitips advanced	57
10.4.1	Purity grade – Eppendorf Quality	57
10.4.2	Purity grade – Sterile	58
10.4.3	Purity grade – Biopur	59
10.4.4	Purity grade – PCR clean	60
10.4.5	Purity grade – Forensic DNA Grade	61
10.4.6	Adapter advanced for dispenser tip	61
10.5	Dispenser tip – ViscoTip	62
10.5.1	Purity grade – Eppendorf Quality	62
10.6	Accessories for Combitips advanced	62
	Index	63
	Certificates	65

Table of contents

- 6 Multipette® E3/E3x – Repeater® E3/E3x
English (EN)

1 Operating instructions







1.1 Using this manual

- ▶ Read this operating manual completely before using the device for the first time. Observe the instructions for use of the accessories where applicable.
- ▶ This operating manual is part of the product. Please keep it in a place that is easily accessible.
- ▶ Enclose this operating manual when transferring the device to third parties.
- ▶ The current version of the operating manual for all available languages can be found on our webpage www.eppendorf.com/manuals.

1.2 Danger symbols and danger levels

1.2.1 Danger symbols

The safety instructions in this manual have the following danger symbols and danger levels:

	Biohazard		Explosive substances
	Electric shock		Toxic substances
	Hazard point		Material damage

1.2.2 Danger levels

DANGER	Will lead to severe injuries or death.
WARNING	May lead to severe injuries or death.
CAUTION	May lead to light to moderate injuries.
NOTICE	May lead to material damage.

1.3 Symbols used

Depiction	Meaning
1. 2.	Actions in the specified order
▶	Actions without a specified order
•	List
<i>Text</i>	Display or software texts
	Additional information

1.4 Glossary

A

Adapter advanced

Connecting piece for the dispenser when using Combitips advanced 25 mL and 50 mL

C

Calibration

Measuring process to reliably and reproducibly determine and document the error of measurement of a dispenser.

Coding

The dispenser uses coding to detect the Combitip's maximum volume.

Color code

The color code displays the maximum volume.

Combitips advanced

Dispensing tip for all Eppendorf Multipipettes and Repeaters. Dispenser tips are single-use consumables which function using the positive displacement principle and consist of a piston and a cylinder.

D

DIN EN ISO 8655

The standard defines limit values for the systematic error, the random error and the test methods for dispensers.

Dispensing volume

Volume per dispensing step.

F

Free jet dispensing

Dispensing of liquid without the dispensing tip (pipette tip, dispenser tip) touching the tube inner wall.

G

Graduation

Incremental graduation of a range, a surface or a volume.

I

Increment

Step size or resolution. The smallest possible change by which a value can be increased.

M

Maximum volume

The maximum volume that can be used for dispensing.

N

Nominal volume

The maximum dispensing volume of a dispensing system specified by the manufacturer.

P

Positive displacement principle

Design characteristic of piston-stroke dispensers. The liquid is in direct contact with the piston of the dispensing tip (Combitip) during aspiration and dispensing operations.

R

Random error

Imprecision. A measure for the scattering (standard deviation) of the measured values around the average value.

Remaining stroke

Liquid reserve. The liquid which remains after all dispensing steps have been completed.

Reverse stroke

After liquid aspiration, the piston is moved to a defined initial position. Liquid is dispensed during the piston movement. The reverse stroke is not a dispensing step.

S

Systematic error

Inaccuracy. Deviation of the average value of the dispensed volumes from the selected volume.

T

Time interval

The period of time between two dispensing steps.

V

ViscoTip

Dispenser tip for highly-viscous liquids with dynamic viscosities between 200 mPa·s and 14000 mPa·s. The ViscoTip is suitable for use in all Eppendorf Multipipettes and Repeaters. Dispenser tips are single-use consumables which function using the positive displacement principle and consist of a piston and a cylinder.

10 **Operating instructions**
Multipette® E3/E3x – Repeater® E3/E3x
English (EN)

W

Wall dispensing

Dispensing liquid against the tube wall. The pipette tip or the dispensing tip is held against the tube inner wall and the liquid is dispensed.

2 Safety

2.1 Intended use

The Multipette E3/E3x – Repeater E3/E3xE3x is a product for general laboratory use and, in combination with a dispenser tip (Combitips advanced or ViscoTip), intended for dispensing liquids in a volume range of 1 μ L – 50 mL. In vivo applications (applications in or on the human body) are not permitted.

The Multipette E3/E3x – Repeater E3/E3x may only be operated by trained specialists. All users must have read the operating manual carefully and familiarized themselves with the device's mode of operation.

2.2 Warnings for intended use



WARNING! Damage to health due to infectious liquids and pathogenic germs.

- ▶ When handling infectious liquids and pathogenic germs, observe the national regulations, the biosafety level of your laboratory, and the manufacturers' Safety Data Sheets and application notes.
 - ▶ Wear your personal protective equipment.
 - ▶ Consult the "Laboratory Biosafety Manual" (source: World Health Organization, Laboratory Biosafety Manual, as amended) for comprehensive regulations on the handling of germs or biological material of risk group II or higher.
-



DANGER! Explosion hazard.

- ▶ Do not operate the device in areas where work with explosive substances is carried out.
 - ▶ Do not use this device to process any explosive or highly reactive substances.
 - ▶ Do not use this device to process any substances that could create an explosive atmosphere.
-



NOTICE! Carry-over, contamination and incorrect dispensing results due to incorrect use of dispenser tips.

Dispenser tips are intended for single use. Prolonged use can have a negative impact on dispensing accuracy.

- ▶ Use dispenser tips only once.
- ▶ Do not use washed or autoclaved dispenser tips for dispensing.

Safety

12 Multipipette® E3/E3x – Repeater® E3/E3x
English (EN)



NOTICE! Damage to device due to penetration of liquid.

- ▶ Only immerse the dispenser tip in the liquid.
 - ▶ Do not put the dispenser down when the dispenser tip is filled.
 - ▶ The dispenser itself may not come into contact with the liquid.
-

3 Product description
3.1 Delivery package

Quantity	Description
1	Multipette E3/E3x - Repeater E3/E3x
9	Combitips advanced
1	ViscoTip
2	Adapter advanced
1	Power supply with power plug adapters
1	Operating manual
1	Short instructions

3.2 Features

The dispenser (Multipette E3/E3x, Repeater E3/E3x) is an electronic dispenser that functions according to the positive displacement principle. The dispenser is used in combination with a dispensing tip (Combitips advanced or ViscoTip) to aspirate and dispense liquids. Depending on the dispenser tip used, volumes between 1 µL and 50 mL can be dispensed.

3.3 Product overview

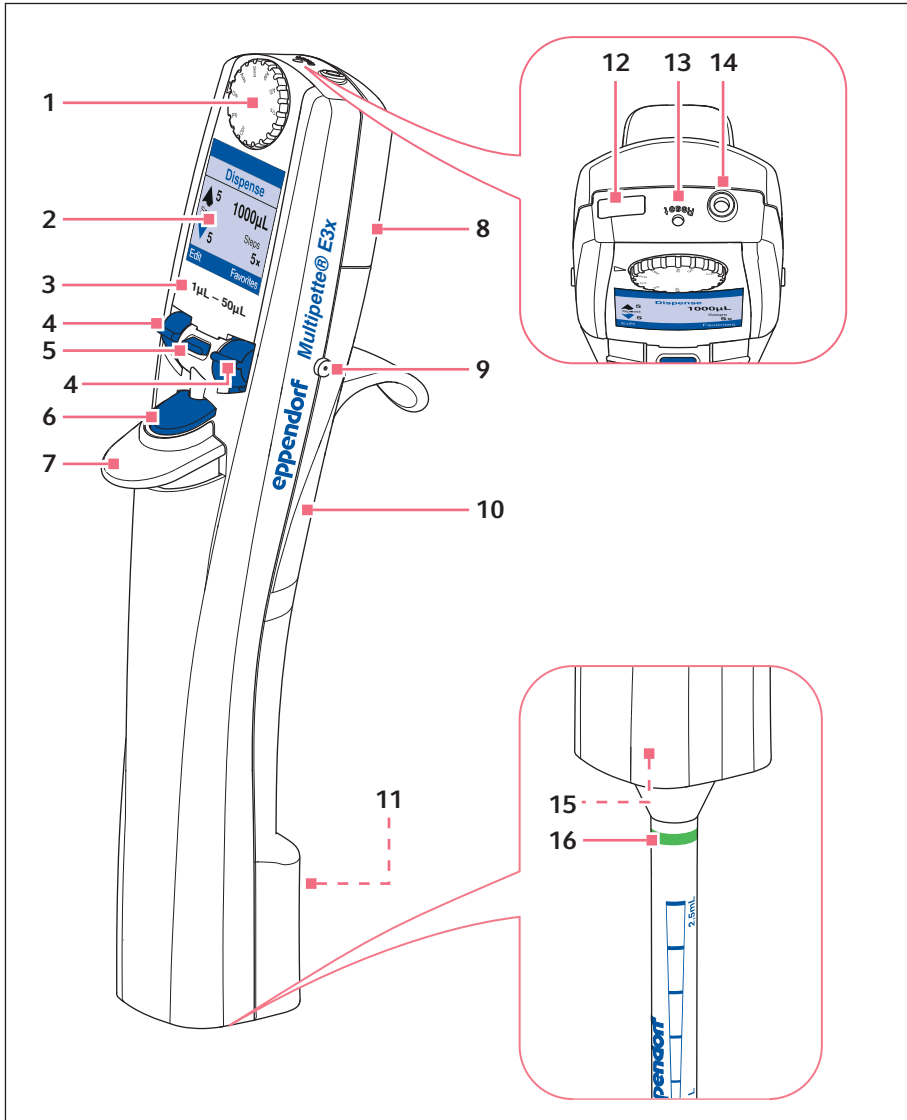

Fig. 3-1: Multipette E3/E3x and Repeater E3/E3x

- 1 Selection dial
Sets the operating mode
- 2 Display
- 3 Volume range
- 4 Rocker
- 5 Softkey
- 6 Actuate key
- 7 Ejector
- 8 Rechargeable battery compartment
- 9 Charging contacts
- 10 RFID chip
- 11 Serial number
- 12 Micro USB interface
- 13 *Reset* key
- 14 Connector socket
- 15 Holder for the dispensing tip
- 16 Dispenser tip

3.4 Layout of the display

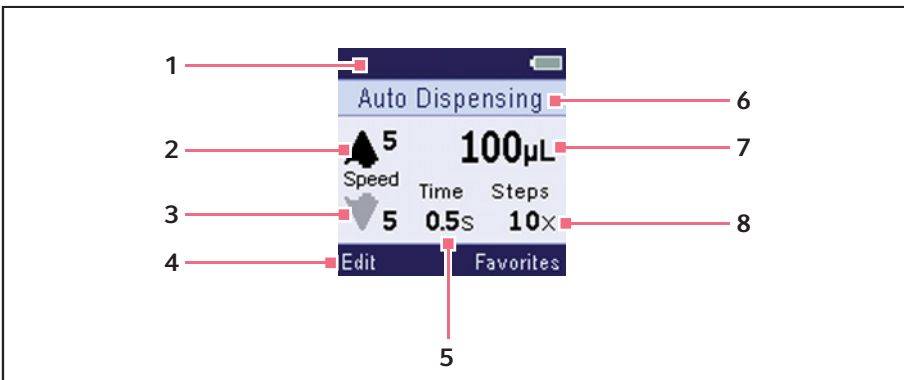

Fig. 3-2: Example layout for the **Ads** operating mode

- 1 Header
- 2 Aspiration speed
- 3 Dispensing speed
- 4 Footer
- 5 Time interval
- 6 Status line
- 7 Dispensing volume
- 8 Number of dispensing steps

Product description

Multipette® E3/E3x – Repeater® E3/E3x
English (EN)

3.5 Operating controls

Operating control	Function
Selection dial	Sets the operating mode.
Actuate key	Triggers dispensing operations, performs dispensing steps, saves parameters, aborts functions.
Ejector	Ejects the dispensing tip.
Rocker	Performs functions that are displayed on the left and right in the footer.
Softkey	Performs functions that are displayed in the footer. Aborts liquid aspiration, aborts functions, aborts liquid dispensing, calls previous screen or confirms error messages.
Reset key	Performs a hardware reset.

3.6 Overview of the operating modes

An overview of the operating modes for the different models.

Selection dial	Mode	Description	Model E3	Model E3x
Opt	Options	Adjustment of device settings (language, volume, etc.)	■	■
Pip	Pipetting	Aspiration of liquid in one step and dispensing of liquid in one step.	■	■
Dis	Dispensing	Aspiration of liquid and dispensing of liquid in equal partial volumes.	■	■
Ads	Automatic dispensing	Aspiration of liquid in one step and automatic dispensing of liquid in equal partial volumes and fixed time intervals.	■	■
Seq	Sequential dispensing	Aspiration of liquid in one step and dispensing of liquid in different partial volumes.	–	■
Asp	Multi-Aspirate	Aspiration of liquid in equal partial volumes.	–	■
A/D	Aspirate and dispensing	Aspiration of an unknown liquid volume. Dispensing of liquid in partial volumes.	–	■
Ttr	Titrate	Aspiration of liquid. Determine the dispensing volume with the actuation key.	–	■

3.7 Mains/power supply device and power plug adapter

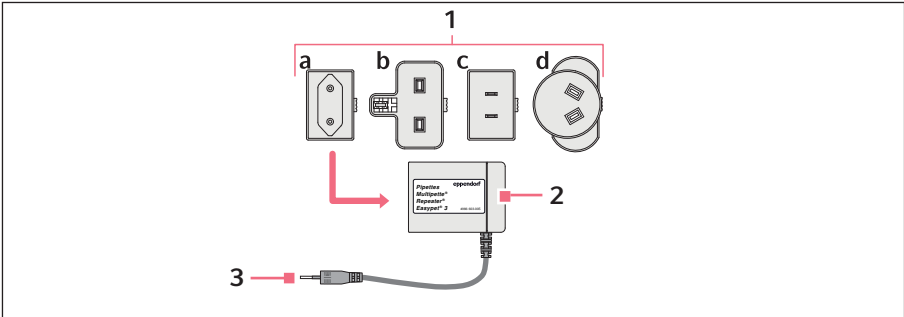

Fig. 3-3: Mains/power supply device with adapters

- 1 Power plug adapter**
 - a Europe
 - b Great Britain
 - c USA
 - d Australia
- 2 Mains/power supply device**
- 3 Charging plug**

3.8 Rechargeable battery charging status.

The charge state of the rechargeable battery is indicated on the display. The display shows a message indicating when the rechargeable battery needs to be charged.

Symbol	Charging status
	The rechargeable battery is fully charged.
	The rechargeable battery is half charged.
	The rechargeable battery is discharged.
	Rechargeable battery charging in progress.

Product description

Multipette® E3/E3x – Repeater® E3/E3x
English (EN)

3.9 Materials

NOTICE! Aggressive substances may damage dispensers, dispenser tips and accessories.

- ▶ Check the chemical resistance when using organic solvents or aggressive chemicals.
- ▶ Observe the cleaning instructions.

Assembly	Material
Dispensing button	Polycarbonate (PC)
Display	Polycarbonate (PC)
Housing parts	Acrylonitrile/styrene/acrylic ester (ASA) with polycarbonate (PC)
Charging contacts	Gold coating
USB cover, rockers, softkeys	Silicone
Selection dial	Acrylonitrile/styrene/acrylic ester (ASA) with polycarbonate (PC)

3.10 Warranty

In case of warranty claims, contact your local Eppendorf contractual partner.

No warranty is given in the following cases:

- In the case of misuse.
- If unauthorized persons open the dispenser.

The following assemblies are excluded from the warranty:

- Rechargeable battery

3.11 Overview of dispenser tips

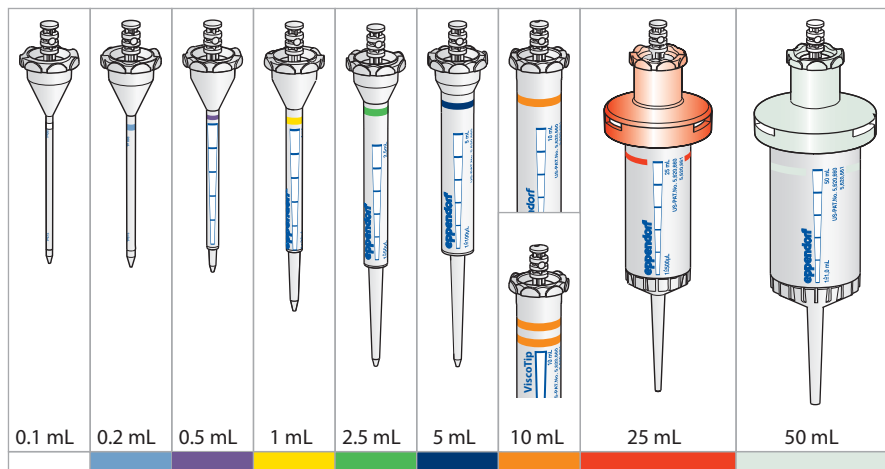

Fig. 3-4: Combitips advanced (one colored ring) and ViscoTip (two colored rings)

3.11.1 Combitips advanced volume ranges

Combitips advanced	Volume range	Increment
0.1 mL white	1.0 μ L – 100 μ L	0.1 μ L
0.2 mL light blue	2.0 μ L – 200 μ L	0.2 μ L
0.5 mL violet	5.0 μ L – 500 μ L	0.5 μ L
1.0 mL yellow	10 μ L – 1000 μ L	1.0 μ L
2.5 mL green	25 μ L – 2500 μ L	2.5 μ L
5.0 mL blue	50 μ L – 5000 μ L	5.0 μ L
10 mL orange	0.1 mL – 10 mL	0.01 mL
25 mL red	0.25 mL – 25 mL	0.025 mL
50 mL light gray	0.5 mL – 50 mL	0.05 mL

Installation

Multipette® E3/E3x – Repeater® E3/E3x

English (EN)

3.11.2 ViscoTip volume range

ViscoTip	Volume range	Increment
10 mL orange	0.1 mL – 10 mL	0.01 mL

4 Installation**4.1 Preparing the dispenser for initial use**

Before the dispenser can be used for the first time, a few preparatory steps need to be carried out once.

- ▶ Assemble the mains/power supply device.
(see *Mains/power supply device assembly on p. 21*)
- ▶ Connect the rechargeable battery.
(see *Connecting the rechargeable battery on p. 23*)
- ▶ Fully charge the rechargeable battery.
(see *Charging the rechargeable battery on p. 24*)
- ▶ Set the date.
(see *Adjusting the Date and time option on p. 43*)

4.2 Mains/power supply device assembly



WARNING! Incorrect or damaged mains/power supply devices can cause severe personal injury and damage to the device.

Incorrect or damaged mains/power supply devices may cause electric shock, overheat the device, set it on fire, melt it, short-circuit it or cause similar damage.

- ▶ Only use the mains/power supply device which is included in the delivery to charge the device. You can identify the correct mains/power supply device by the Eppendorf logo and the device name on the mains/power supply device.
- ▶ Do not use damaged mains/power supply devices.

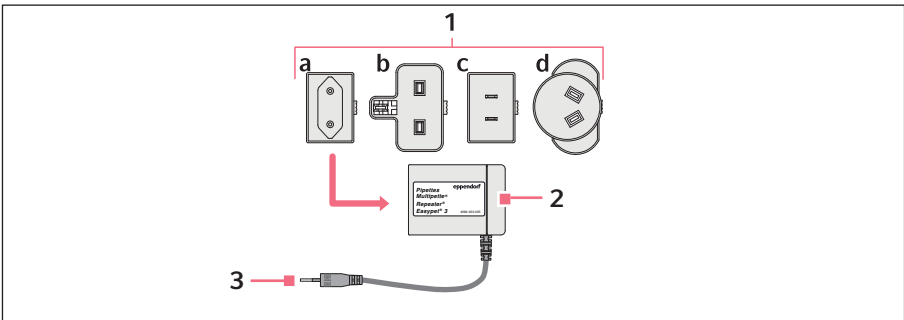

1 Power plug adapter

- a EU
- b United Kingdom
- c USA
- d Australia

3 Charging plug

2 Mains/power supply device

Installation

Multipipette® E3/E3x – Repeater® E3/E3x

English (EN)

4.2.1 Identifying the mains/power supply device

The original mains/power supply device from Eppendorf is labeled with the compatible dosing devices, the order number and the Eppendorf logo.

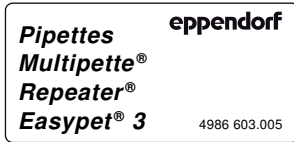
**4.2.2 Inserting the power plug adapter**

1. Select the appropriate power plug adapters for the mains/power line.
2. Push the power plug adapter on the mains/power supply device until it locks into place.

4.2.3 Replace the power plug adapter.

1. Press and hold down the release on the mains/power supply device.
2. Disconnect the power plug adapter.
3. Select the appropriate power plug adapters for the mains/power line.

4.3 Connecting the rechargeable battery



WARNING! Personal injury due to incorrect handling of the rechargeable battery.

- ▶ Only use rechargeable batteries supplied by Eppendorf.
- ▶ Never pierce, crush or throw the rechargeable battery.
- ▶ Only use the rechargeable battery in the supplied device.
- ▶ Do not touch a leaking rechargeable battery.
- ▶ Do not use a damaged rechargeable battery.
- ▶ Dispose of rechargeable batteries in accordance with the legal requirements.

The rechargeable battery must be fully charged before it is used for the first time.

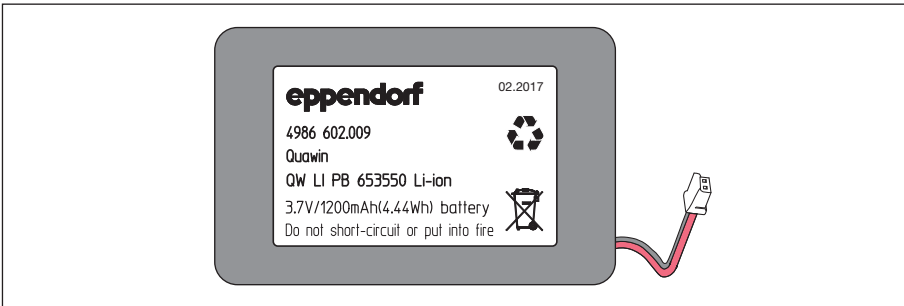
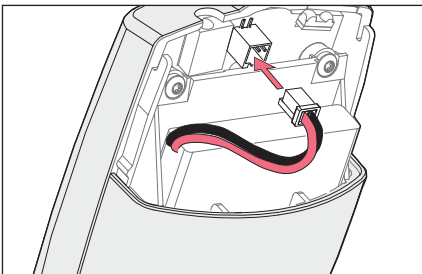

Fig. 4-1: Original rechargeable battery from Eppendorf with Eppendorf logo, date of production and order number



1. Remove the rechargeable battery compartment lid.
2. Remove the notice.
3. Insert the rechargeable battery.
4. Connect the connector to the connector socket.
5. Attach the rechargeable battery compartment lid.

5 **Operation**

5.1 **Charging the rechargeable battery**



NOTICE! Loss of full charging capacity of the rechargeable battery if charged incorrectly.

The supplied rechargeable battery is not fully charged. The rechargeable battery will only reach its full capacity after several discharging and charging cycles.

- ▶ Do not charge the rechargeable battery in a hot environment (> 60 °C).
- ▶ Only charge the rechargeable battery using the supplied mains/power supply device.



NOTICE! Material damage due to outdated rechargeable battery.

If the rechargeable battery exceeds its service life, the rechargeable battery may become deformed or burst.

- ▶ Replace the rechargeable battery when the housing is deformed.
 - ▶ Replace the rechargeable battery if the charging cycles are unusually short.
 - ▶ Replace the rechargeable battery if it is older than 3 years.
-



If a rechargeable battery is highly discharged, a minimum charge state is required before the dispenser can be used.

The display shows a message indicating when the rechargeable battery needs to be charged.

5.1.1 **Charging the rechargeable battery with the mains/power supply device**

Prerequisites

- The rechargeable battery is connected.
1. Insert the mains/power supply device into the socket.
 2. Connect the charging plug to the connector socket of the dispenser.
The charging process is shown on the display.
The rechargeable battery symbol flashes during charging.

5.1.2 Charging the rechargeable battery in the charger stand or in the charger carousel



NOTICE! Damage to the pipette due to excessive charging current.

Electronic pipettes or dispensers must not be connected to a mains/power supply device while being in a charger stand or charger carousel. This may destroy the electronics of the pipette and the pipette may catch fire.

- ▶ Disconnect any connected mains/power supply devices from the pipette or the dispenser.
- ▶ It is not permitted to use the mains/power supply device of the pipette and the charger stand or charger carousel in combination.

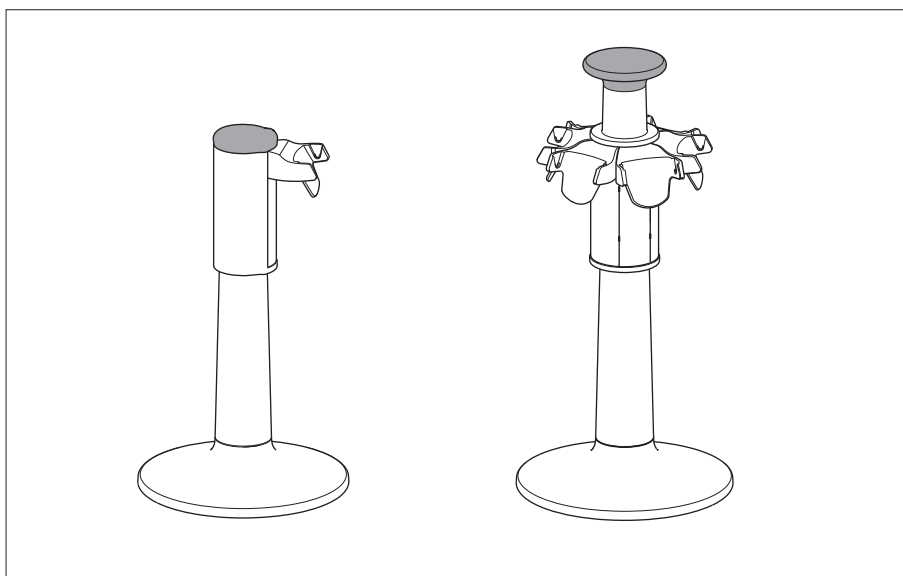

Fig. 5-1: Charger stand and charger carousel

Prerequisites

- The mains/power supply device has been connected.
 - The charger shell for the dispenser has been inserted.
1. Place the dispenser with the charging contacts into the charger shell.
The charging process is shown on the display.

Operation

Multipipette® E3/E3x – Repeater® E3/E3x

English (EN)

5.2 Preserving the battery capacity

The battery capacity can be preserved over the service life to a great extent.

5.2.1 Longer periods without operation – with charger stand

- ▶ Store the pipette in the plugged-in charger stand.
The charging status of the rechargeable battery is automatically monitored and charged.

5.2.2 Longer periods without operation – without charger stand

1. Charge the battery completely if the pipette is not used for a longer period of time (> 4 weeks).
2. Recharge the battery completely every 2 months.

5.2.3 Replacing the rechargeable battery

1. Open the rechargeable battery compartment lid.
2. Loosen the connector of the rechargeable battery from the connector socket.
3. Remove the rechargeable battery.
4. Insert a new battery.
5. Connect the connector of the rechargeable battery to the connector socket.
6. Close the rechargeable battery compartment lid.

5.3 Switching the dispenser on or off

The dispenser automatically switches on or off. A sensor registers a movement and switches on the dispenser. If the dispenser is not moved or operated for about 2.5 minutes, it switches to standby mode.

5.4 Sets the operating mode

Selection dial	Mode
Pip	Pipetting
Dis	Dispensing
Ads	Automatic dispensing
Seq	Sequential dispensing
Asp	Multiple aspiration
A/D	Aspiration and dispensing
Ttr	Titration
Opt	Options

- ▶ Set the desired operating mode on the selection dial.

5.5 Dispenser tip



NOTICE! Damage to device due to incorrect dispenser tip.

The dispenser shaft is built to hold only the Combitips advanced or ViscoTip dispenser tips. Other dispenser tips can damage the holder.

- ▶ Please only use Eppendorf brand dispenser tips (Combitips advanced or ViscoTip).



NOTICE! Damage to device due to incorrect handling of the inserted dispenser tip.

- ▶ Insert the dispenser tip straight into the dispenser from below.
- ▶ Do not turn the inserted dispenser tip.
- ▶ Never hold the dispenser by the dispenser tip.

5.5.1 Inserting the dispenser tip



If you keep the ejector pushed down while inserting the dispenser tip, it will be easier to insert the dispenser tip.

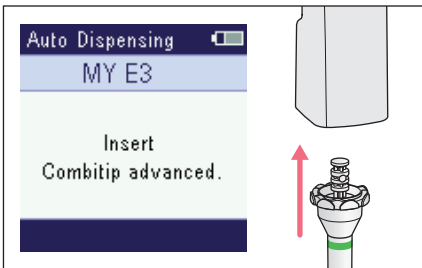

1. Select a dispenser tip.
2. Insert the dispenser tip straight from below.
 The size of the dispenser tip is shown on the display.

5.5.2 Ejecting the dispenser tip

Prerequisites

- The dispenser tip has been emptied.

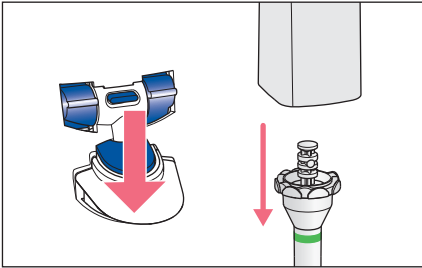

1. Hold the dispenser tip over a waste container.
2. Press the ejector.
The dispenser tip is ejected.

5.6 Overview of parameters

In the operating modes it is possible to change the parameters listed.

Parameter	Pip	Dis	Ads	Seq	Asp	A/D	Ttr
Dispensing volume	■	■	■	■	–	■	–
Aspiration volume	–	–	–	–	■	–	–
Aspiration speed	■	■	■	■	■	■	■
Dispensing speed	■	■	■	■	■	■	■
Time interval	–	–	■	–	–	–	–
Number of dispensing steps	–	■	■	■	–	■	–
Number of aspiration steps	–	–	–	–	■	–	–

5.6.1 Change Parameter

Prerequisites

- The operating mode has been set.
- The dispensing tip has been inserted.

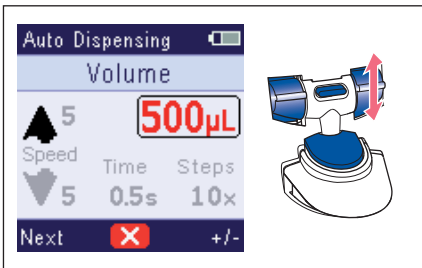

1. Press the *Edit* rocker.
The parameter that can be changed is highlighted.
2. Select the desired parameter with the *Next* rocker.
3. Change the parameter value with the +/- rocker.
4. To save the parameter value, press the actuation key.

- i** The process of changing the parameters can be aborted with the middle softkey. Any changes made are not saved.
- i** The speeds for the aspiration and dispensing of liquids must be adapted to the physical properties of the respective liquid. A liquid with a high viscosity can only be aspirated slowly.

5.7 Aspirating liquid

Prerequisites

- The **Pip**, **Dis**, **Ads**, **Seq** or **Ttr** operating mode has been set.
- The dispensing tip has been inserted.

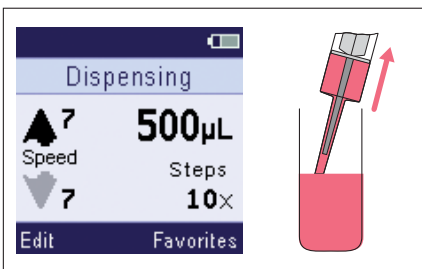

1. Immerse the dispensing tip into the liquid in the source vessel.
2. Press the actuation key.
3. Wait until the set volume has been aspirated.
4. Slowly draw the dispensing tip out of the liquid.

- i** The aspiration of liquid can be aborted with the middle softkey or the actuation key. The aspirated liquid can be used for a subsequent liquid dispensing operation.

5.8 Carrying out a reverse stroke

Before liquid can be dispensed, the piston of the dispenser must be brought into a defined starting position. The liquid dispensed during this process does not belong to the dispensing steps and should be discarded.

Prerequisites

- The **Pip**, **Dis**, **Ads**, **Seq**, **A/D** or **Ttr** operating mode has been set.
- Liquid has been aspirated.

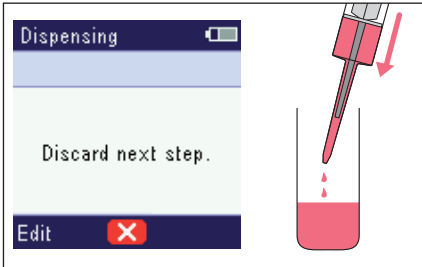

1. Hold the dispensing tip over a waste container.
2. Press the actuate key.
The reverse stroke is performed.
The set operating mode is displayed.
The liquid can be dispensed.

5.9 Pip operating mode – Pipetting of liquid

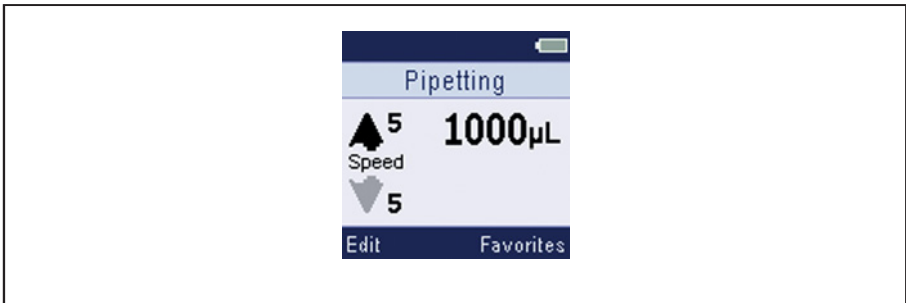

Fig. 5-2: Screen for the **Pip** operating mode

Aspirating liquid in one step and dispensing liquid in one step.

Application example:

- Refilling of liquids.

Prerequisites

- The volume has been set.
- The aspiration speed and dispensing speed have been set.

1. Aspirate the liquid.
2. Press the actuation key.
The reverse stroke is performed.
3. Hold the dispensing tip over the destination vessel.
4. Press the actuation key.
The liquid is dispensed in one step.

5.10 Dis operating mode – Dispensing of liquid

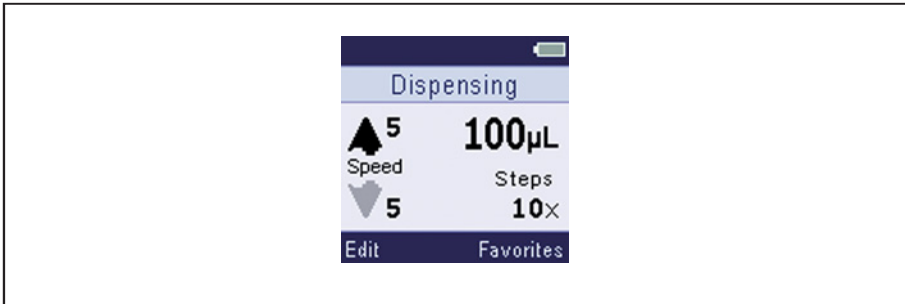

Fig. 5-3: Screen for the **Dis** operating mode

Dispensing of liquid in equal partial volumes. The smallest dispensing volume allows for a maximum of 100 dispensing steps.

Application example:

- Filling a plate (e.g., a 96-well plate or a 384-well plate).

Prerequisites

- The volume has been set.
- The aspiration speed and the dispensing speed have been set.
- The number of dispensing steps has been set.

1. Aspirate the liquid.
2. Press the actuation key.
The reverse stroke is performed.
The volume of the next dispensing step and the number of remaining dispensing steps are displayed.
3. Hold the dispensing tip over the first well in the destination vessel.
4. Press the actuation key.
The liquid is dispensed.
The remaining dispensing steps are displayed.
5. Perform further dispensing steps.

5.11 Ads operating mode – Automatic dispensing of liquid

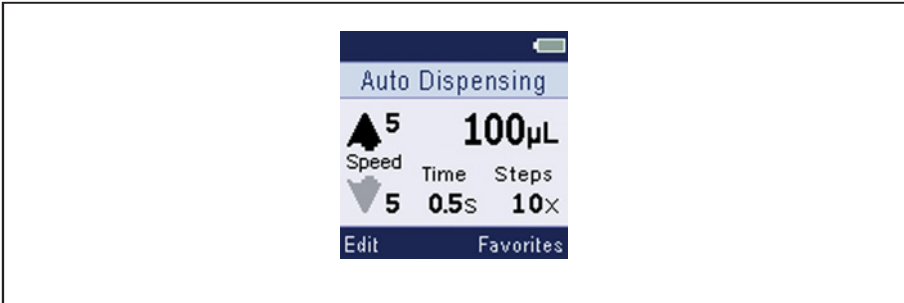

Fig. 5-4: Screen for the **Ads** operating mode

Automatic dispensing of aspirated liquid in equal partial steps.

Application example:

- Quick completion of a long dispensing series.

Prerequisites

- The volume has been set.
- The aspiration speed and dispensing speed have been set.
- A time interval has been set.
- The number of dispensing steps has been set.

1. Aspirate the liquid.

2. Press the actuation key.

The reverse stroke is performed.

3. Hold the dispensing tip over the first destination vessel.

i To pause automatic liquid dispensing, release the actuation key.

4. Press and hold down the actuation key and hold the dispensing tip over the next destination vessel within the time interval.

The liquid is automatically dispensed after the time interval has elapsed.

The volume of the next dispensing step is displayed.

The remaining dispensing steps are displayed.

5.12 Seq operating mode – Sequential dispensing of liquid

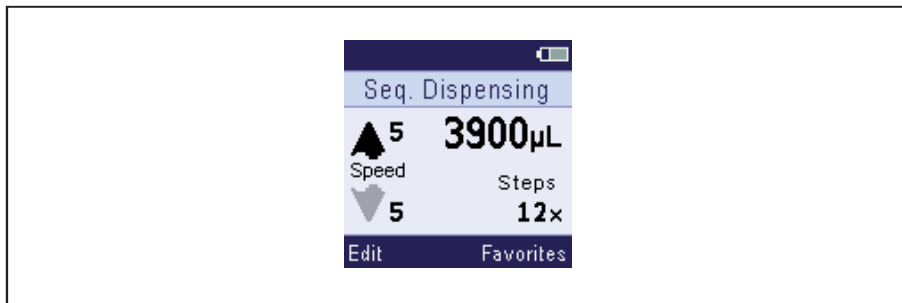

Fig. 5-5: Screen for the **Seq** operating mode

Dispensing of liquid in different partial volumes. If the total volume of the dispensing steps exceeds the nominal volume of the dispensing tip, repeat aspiration of liquid will be necessary between the dispensing steps.

Application example:

- Creation of a dilution series.

Prerequisites

- The volume of each dispensing step has been set.
- The number of dispensing steps (a maximum of 16) has been set.
- The aspiration speed and dispensing speed have been set.

1. Aspirate the liquid.
2. Press the actuation key.
The reverse stroke is performed.
3. Hold the dispensing tip over the first destination vessel.
4. Press the actuation key.
The first dispensing step is performed.
The volume of the next dispensing step is displayed.
The number of the next dispensing step and the total number of dispensing steps are displayed.
5. Perform further dispensing steps.

5.13 Asp operating mode – Multiple liquid aspiration

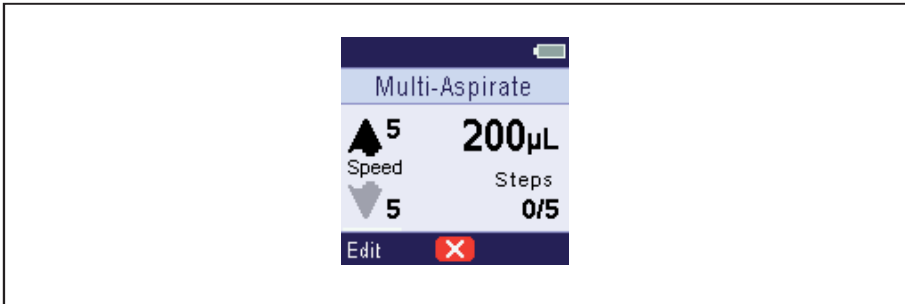

Fig. 5-6: Screen for the **Asp** operating mode

Multiple aspiration of a defined volume of liquid in succession. The liquid is dispensed in a dispensing step.

Application example:

- Aspiration of an equal volume from different wells in a plate.

Prerequisites

- Volume has been set.
- The number of aspiration steps has been set.

1. Press the actuation key.
The piston moves to the start position.
The set volume is displayed.
The number of aspiration steps is displayed.
2. Aspirate liquid from the first source vessel.
The current aspiration step is displayed
3. Perform further aspiration steps.
4. Hold the dispensing tip over a waste container.
5. Press the *Empty* softkey.

5.14 A/D operating mode – Aspiration and dispensing of liquid

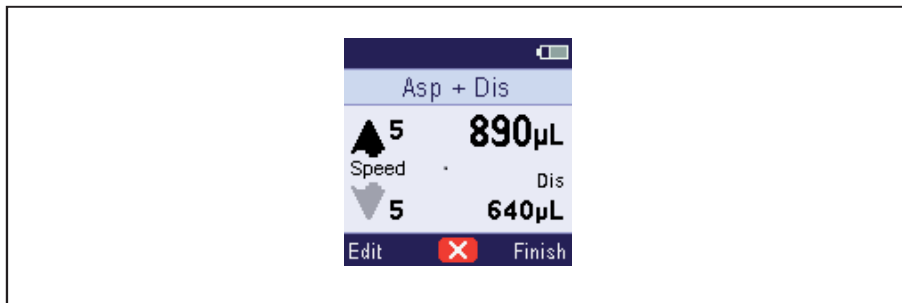

Fig. 5-7: Screen for the **A/D** operating mode

Aspirate the liquid with an unknown volume and then dispense it.

Application example:

- Aspiration of liquid supernatant and distribution to destination vessels.

Prerequisites

- The aspiration speed has been set.

1. Press the actuation key.
The piston moves to the start position.
2. Press and hold down the actuation key until the liquid has been aspirated.
The aspirated volume is displayed.
The volume available for dispensing is displayed.
3. Press the *Finish* rocker.
The dispensing mode is active.
The dispensing volume and the dispensing speed can be changed.
4. Hold the dispensing tip over a waste container and press the actuation key.
The reverse stroke is performed.
5. Hold the dispensing tip over a destination vessel and dispense liquid.
The number of the remaining dispensing steps is displayed.
6. Perform further dispensing steps.
7. Hold the dispensing tip over a waste container and discard the residual liquid.

5.15 Ttr operating mode – Titration of liquid

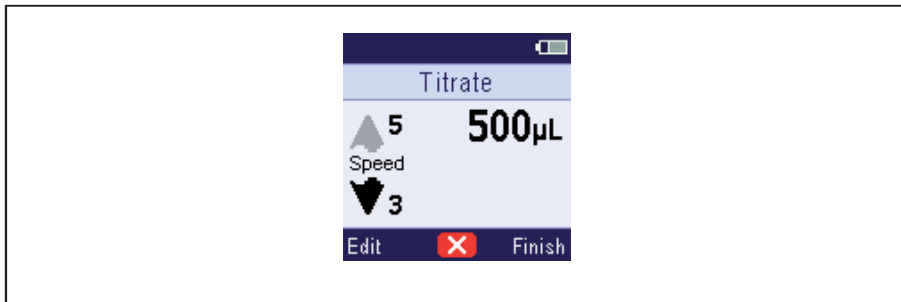

Fig. 5-8: Screen for the **Ttr** operating mode

Determining the dispensing volume of the titration using the actuate key.

Application example:

- Performing a titration.

Prerequisites

- The aspiration speed and the dispensing speed have been set.

1. Aspirate the liquid.
2. Press the actuate key.
The reverse stroke is performed.
3. Hold the dispenser tip over a destination vessel.
4. Press and hold down the actuate key.
Liquid is dispensed.
5. To pause the titration, release the actuate key.
The dispensed volume is displayed.
6. To continue the titration, press and hold down the actuate key.
The dispensing speed decreases with each dispensing step.
7. Press the *Finish* rocker.
Liquid can be discarded or a new titration can be started.

5.15.1 Displaying the data of the last titration

Prerequisites

- At least one titration has been performed.

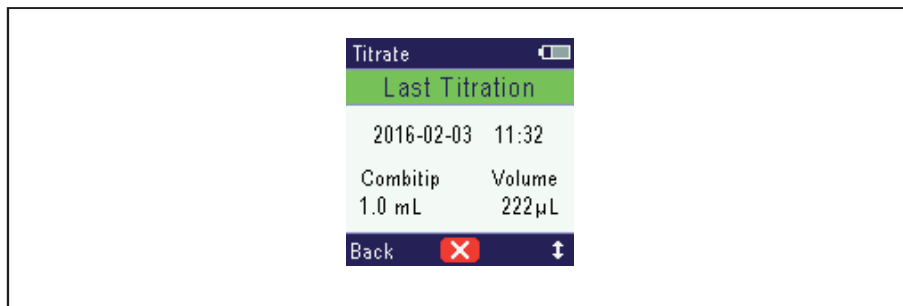

Fig. 5-9: Screen for *Last Ttr*

1. Press the arrow up/arrow down rocker.
The data for the last titration is shown.
2. Arrow up/arrow down can be used to select the last 5 data records.
3. Press the *Back* rocker.
The **Ttr** operating mode is displayed.

5.16 Renewed aspiration

Prerequisites

- The **Pip, Dis, Ads, Seq** or **Ttr** operating mode has been set.
- Dispensing has been completed.

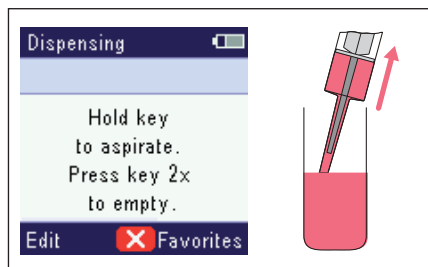

1. Immerse the dispensing tip into the liquid in the source vessel.
2. Press and hold down the actuation key.
The dispensing tip is filled.

5.17 Emptying the dispensing tip

Prerequisites

- Dispensing has been completed.

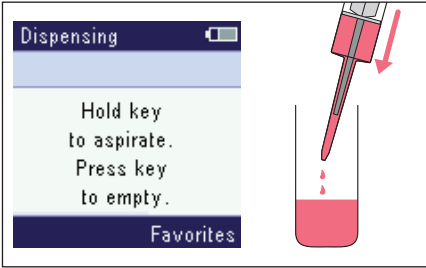

1. Hold the dispensing tip over a waste container.
2. Press the actuate key or the middle softkey.
The dispensing tip is emptied.

5.18 Opt operating mode – Adjustment of device settings

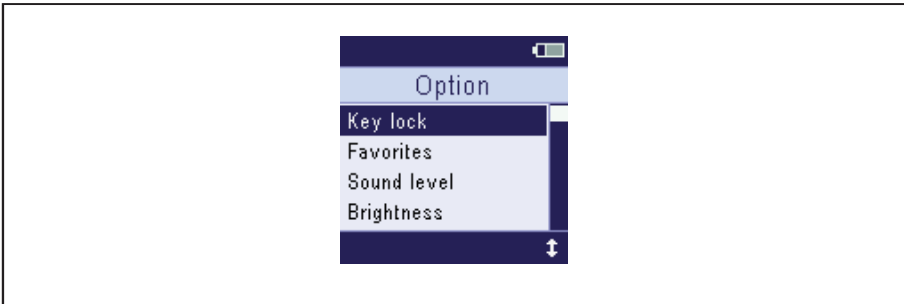

Fig. 5-10: Screen for the **Opt** operating mode

Device setting	Meaning	Value
<i>Key lock</i>	Activate/deactivate key lock	<i>On/Off</i>
<i>Favorites</i>	Activate/deactivate favorites	<i>On/Off</i>
<i>Sound level</i>	Activate/deactivate acoustic signal	<i>On/Off</i>
<i>Brightness</i>	Adjust brightness	1 – 8

Device setting	Meaning	Value
<i>Language</i>	Select language	<ul style="list-style-type: none"> • <i>Chinese</i> – Chinese • <i>Dutch</i> – Dutch • <i>English</i> – English • <i>French</i> – French • <i>German</i> – German • <i>Italian</i> – Italian • <i>Japanese</i> – Japanese • <i>Portuguese</i> – Portuguese • <i>Spanish</i> – Spanish
<i>Personalization</i>	Personally identify dispenser	Free text (10 digits)
<i>Service</i>	Access service functions	<ul style="list-style-type: none"> • <i>Software version</i> • <i>Initial reset</i> • <i>Self test</i>
<i>Reminder</i>	Reminder function for the next service	<ul style="list-style-type: none"> • <i>Last service</i> • <i>Next service</i> • <i>Interval</i> • <i>Reset</i>
<i>Date and time</i>	Setting date and time	<ul style="list-style-type: none"> • <i>Date</i> – YYYY-MM-DD • <i>Hour</i> – hh:mm
<i>Screen saver</i>	Activate/deactivate screen saver	<i>On/Off</i>

5.18.1 Selecting a menu item

1. Select a menu item with the *arrow up/arrow down* rocker.
2. To open a menu item, press the actuation key.

5.18.2 Changing an option

 The process of changing an option can be aborted with the middle softkey.

1. Change the option with the *+/-* rocker.
2. To save the change, press the actuation key.

The key lock blocks changes to parameters and options.

5.18.3 Activating/deactivating the *Key lock* option



Fig. 5-11: Screen for the *Key lock* option

The key lock option is used to block changes to parameters and adjustments to options.

Status	Meaning
<i>On</i>	Key lock is activated
<i>Off</i>	Key lock is deactivated

5.18.4 Activating/deactivating the *Favorites* option

When activated, the favorites option allows frequently used parameter settings to be saved. It is possible to save parameters for the **Pip**, **Dis**, **Ads**, **Seq** and **Asp** operating modes.

Status	Meaning
<i>On</i>	The use of favorites is activated
<i>Off</i>	The use of favorites is deactivated

5.18.5 Activating/deactivating the *Sound level* option

The acoustic feedback of the operating controls can be activated or deactivated.

Status	Meaning
<i>On</i>	Acoustic feedback is activated
<i>Off</i>	Acoustic feedback is deactivated

5.18.6 Adjusting the *Brightness* option



Fig. 5-12: Screen of the *Brightness* option

The screen brightness can be adjusted in 8 stages.

5.18.7 Adjusting the *Language* option



Fig. 5-13: Screen of the *Language* option

In each language the menu item remains set to *Language*. This makes it easier to set your own language.

1. Select the *Language* option.
2. Select the desired language with the *arrow up/arrow down* rocker.
3. To save the marked language, press the actuation key.

5.18.8 Saving the *Personalization* option

The dispenser can be personalized, for example, in order to assign it to a specific lab or department. For this, a free text can be entered with a maximum of 10 digits. The personalization setting is displayed when the rechargeable battery is charged (mains/power supply device, charger stand or pipette carousel).

1. Mark *Personalization* with the rocker and confirm with the actuation key.
2. Select the item with the *Next* rocker and set the desired letter with the +/- rocker.
3. To save the text, press the actuation key.

5.18.9 Accessing the *Service* option

Service functions	Meaning
<i>Software version</i>	Displays the version number of the software.
<i>Initial reset</i>	Resets all parameters, favorites and adjusted options to the factory settings. The changes must be confirmed.
<i>Self test</i>	Performs a device self test. The test checks the movement of the piston. If the test result is negative, contact the authorized service. The test is not a replacement for regular calibration.

5.18.10 Performing the *Self test* service function

Prerequisites

- The dispensing tip has been inserted.
 - The *Service* option has been selected.
1. Mark *Self test* and confirm with the actuation key.
 2. Start the self test with the *Yes* rocker.
 3. Confirm the result.

5.18.11 Setting the *Reminder* service function

Function	Meaning
<i>Last service</i>	Displays the date when the last service or gravimetric test was performed.
<i>Next service</i>	Displays the date for the next service with an indication of the remaining months and days.
<i>Interval</i>	Sets the period until the next service. 0 disables the function.
<i>Reset</i>	Resets the counter for the reminder function to zero. A reminder will appear after the specified period has elapsed.

5.18.12 Adjusting the *Date and time* option

1. Select the date.
2. Select the year, month or day with the *Next* rocker.
3. Change the value with the +/- rocker.
4. Save the date with the actuation key.
5. Select the time.
6. Select the hour or minute with the *Next* rocker.
7. Change the value with the +/- rocker.
8. Save the time with the actuation key.

5.18.13 Activating/deactivating the *Screen saver* option

The screen saver is displayed when the rechargeable battery is charged (mains/power supply device, charger stand or pipette carousel).

The screen saver shows:

- Date and time
- Personalization
- Rechargeable battery status

5.19 Option of creating *Favorites*

The **Pip**, **Dis**, **Ads**, **Seq** und **Asp** operating modes allow frequently used parameter settings to be saved and accessed. A maximum of five parameter sets can be saved.

5.19.1 Accessing *Favorites*

Prerequisites

- *Favorites* have been enabled.
- An operating mode has been set.
- At least one parameter set is saved.

1. Press the *Favorites* rocker.
The display shows the first parameter set *Favorit 1*.
2. Use the *arrow up/arrow down* rocker to select the desired parameter set
3. Confirm the parameter set with the actuation key.
The parameter set is loaded.
Dispensing can be started.

5.19.2 Editing *Favorites*

- *Favorites* have been enabled.
 - An operating mode has been set.
 - At least one parameter set is saved.
1. Press the *Favorites* rocker.
 2. Use the *arrow up/arrow down* rocker to select the desired parameter set
 3. Press the *Edit* rocker.
 4. Select the parameter with *Next* and change with +/-.
 5. Save the changed parameters with the actuation key.
-  The middle softkey can be used to abort the function. Any changes made are not saved.

6 Troubleshooting
6.1 General errors
6.1.1 Dispenser

Problem	Cause	Solution
The dispenser does not work.	• The rechargeable battery is not charged.	▶ Charge the rechargeable battery.
	• The rechargeable battery is defective.	▶ Replace the rechargeable battery.
	• The dispenser is defective.	▶ Send the dispenser to the authorized service.

6.1.2 Rechargeable battery

Problem	Cause	Solution
The empty battery symbol appears on the display.	• The rechargeable battery is discharged.	▶ Charge the rechargeable battery.
Very short charging cycles.	• The rechargeable battery capacity is reduced significantly. • The rechargeable battery is more than 3 years old.	▶ Replace the rechargeable battery.
The rechargeable battery housing is deformed or bulged.	• The rechargeable battery is more than 3 years old.	▶ Replace the rechargeable battery.

6.1.3 Display

Problem	Cause	Solution
The display is dark.	• The rechargeable battery is discharged.	▶ Charge the rechargeable battery.
	• The rechargeable battery is defective.	▶ Replace the rechargeable battery.

6.1.4 Dispenser tip – Combitips advanced

Problem	Cause	Solution
It is not possible to eject the dispenser tip.	<ul style="list-style-type: none">• The dispenser tip has not been emptied.	<ul style="list-style-type: none">▶ Empty the dispenser tip.
The dispenser tip is difficult to insert.	<ul style="list-style-type: none">• The dispenser tip has got stuck in the retaining claws.	<ul style="list-style-type: none">▶ When inserting the dispenser tip, press the ejector button at the same time.

7 Maintenance

7.1 Service options

Eppendorf recommends having your device checked and maintained by trained specialist personnel at regular intervals.

Eppendorf offers you tailor-made service solutions for the preventive maintenance, qualification and calibration of your device. For information, offers and contact options, please visit www.eppendorf.com/epservices.

7.2 Cleaning

7.2.1 Cleaning and disinfecting the housing



NOTICE! Damage to device from unsuitable cleaning agents or sharp or pointed objects.

Use of unsuitable cleaning agents may damage the device.

- ▶ Do not use caustic cleaning agents, strong solvents or abrasive polishes.
- ▶ Check the compatibility with the materials used.
- ▶ Please note the information on chemical resistance.
- ▶ Do **not** clean the device with acetone or organic solvents with a similar effect.
- ▶ Do **not** use sharp objects to clean the device.



NOTICE! Damage to device due to penetration of liquid.

- ▶ Only immerse the pipette tip in the liquid.
 - ▶ Do not put the pipette down when the pipette tip is filled.
 - ▶ The pipette itself may not come into contact with the liquid.
-



Observe the chemical resistance of the materials.

1. Moisten a cloth with a cleaning agent, a decontamination agent or isopropyl (70 %).
2. Remove any contamination on the outside.
3. Moisten the cloth with water.
4. Wipe down the housing and remove residual cleaning agent.

7.3 Decontamination

-  The dispenser can be decontaminated with UV light. This may lead to permanent discoloration of the material. The discoloration has no effect on the functionality of the dispenser.

7.4 Updating the software

To update the pipette software, follow the "Eppendorf Pipette Software Update Tool" instructions for use. The current version can be found on the Internet at www.eppendorf.com/manuals.

8 Technical data
8.1 Adjustable sub-steps

Model – volume range	Increment
1 µL – 100 µL	0.1 µL
2 µL – 200 µL	0.2 µL
5 µL – 500 µL	0.5 µL
10 µL – 1000 µL	1 µL
25 µL – 2500 µL	2.5 µL
50 µL – 5000 µL	5 µL
0.1 mL – 10 mL	0.01 mL
0.25 mL – 25 mL	0.025 mL
0.5 mL – 50 mL	0.05 mL

8.2 Dispensing speeds

Combitips advanced	Time interval	Speed level							
		1	2	3	4	5	6	7	8
1 mL	Aspiration time [s]	65	33	22	14	6.5	5.5	4.4	3.4
	Dispensing time [s]	60	30	20	12.5	6	5	4.2	3.2
10 mL	Aspiration time [s]	65	44	27	16.5	8.3	6.7	5.2	3.5
	Dispensing time [s]	60	40	25	15	7.8	6.3	4.8	3.3
25 mL	Aspiration time [s]	98	54	33	19	11.7	9.5	7.3	5.2
	Dispensing time [s]	90	50	30	17.8	10.8	8.8	6.8	4.8
50 mL	Aspiration time [s]	98	65	38	22	13.3	11	8.8	6.8
	Dispensing time [s]	90	60	35	20	12.3	10.3	8.3	6.3

Test conditions:

- Average value of 3 determinations
- Liquid: distilled water (according to ISO 3696)
- Ambient temperature: 20 °C – 25 °C

Technical data

Multipette® E3/E3x – Repeater® E3/E3x
English (EN)

8.3 Dispenser

Interface	Micro USB
Weight	approx. 190 g

8.3.1 Rechargeable battery

Type	Rechargeable lithium-ion battery
Nominal voltage	3.7 V
Rated capacity	1200 mAh
Charging time	approx. 2 h
Weight	approx. 26 g

8.3.2 Information on the battery life

Battery life depends on various factors. The full battery capacity is sufficient for at least 500 aspirations and 10000 dispensing steps under the specified test conditions. Under these conditions, the battery life is approx. 5 hours.

Test conditions:

- Combitip advanced 10 mL
- distilled water (according to ISO 3696)
- fully charged, new battery
- speed level 5 for aspiration and dispensing
- 20 dispensing steps are performed per aspiration
- 500 µL of liquid are dispensed per dispensing step

8.3.3 Mains/power supply device

Type	Power supply with power plug adapters
Input voltage	100 V – 240 V, 50/60 Hz, 0.25 A
Output voltage	5 V, 1A, 5 W

8.4 Errors of measurement

Test tip Combitips advanced	Volume range	Testing volume	Error of measurement			
			systematic		random	
			± %	± µL	± %	± µL
0.1 mL white	1 µL – 100 µL	1 µL	11	0.11	14	0.14
		10 µL	1.6	0.16	2.5	0.25
		50 µL	1	0.5	1.5	0.75
		100 µL	1	1	0.5	0.5
0.2 mL light blue	2 µL – 200 µL	2 µL	4	0.08	5.5	0.11
		20 µL	1.3	0.26	1.5	0.3
		100 µL	1	1	1	1
		200 µL	1	2	0.5	1
0.5 mL violet	5 µL – 500 µL	5 µL	3	0.15	6	0.3
		50 µL	0.9	0.45	0.8	0.4
		250 µL	0.9	2.25	0.5	1.25
		500 µL	0.9	4.5	0.3	1.5
1 mL yellow	10 µL – 1000 µL	10 µL	3.5	0.35	7	0.7
		100 µL	0.9	0.9	0.55	0.55
		500 µL	0.6	3	0.3	1.5
		1000 µL	0.6	6	0.2	2
2.5 mL green	25 µL – 2500 µL	25 µL	2	0.5	3.5	0.875
		250 µL	0.8	2	0.45	1.125
		1250 µL	0.5	6.25	0.3	3.75
		2500 µL	0.5	12.5	0.15	3.75
5 mL blue	50 µL – 5000 µL	50 µL	2.5	1.25	6	3
		500 µL	0.8	4	0.35	1.75
		2500 µL	0.5	12.5	0.25	6.25
		5000 µL	0.5	25	0.15	7.5
10 mL orange	0.1 mL – 10 mL	0.1 mL	1.5	1.5	3.5	3.5
		1 mL	0.5	5	0.25	2.5
		5 mL	0.4	20	0.25	12.5
		10 mL	0.4	40	0.15	15

Technical data

Multipette® E3/E3x – Repeater® E3/E3x
English (EN)

Test tip Combitips advanced	Volume range	Testing volume	Error of measurement			
			systematic		random	
			± %	± µL	± %	± µL
25 mL red	0.25 mL – 25 mL	0.25 mL	2.5	6.25	3	7.5
		2.5 mL	0.3	7.5	0.35	8.75
		12.5 mL	0.3	37.5	0.25	31.25
		25 mL	0.3	75	0.15	37.5
50 mL light gray	0.5 mL – 50 mL	0.5 mL	2	10	3	15
		5 mL	0.3	15	0.5	25
		25 mL	0.3	75	0.2	50
		50 mL	0.3	150	0.15	75

Test conditions and test evaluation in compliance with ISO 8655, Part 6. Tested using a standardized analytical balance with evaporation protection.

- Number of determinations: 10
- Use of water in accordance with ISO 3696
- Test was carried out with a Combitip advanced that was filled to capacity
- Tested at 20 °C – 27 °C, ±0.5 °C
- Dispensing onto the tube inner wall
- Speed level: 5



The three largest testing volumes per tip (100 %, 50 %, 10 % of the nominal volume) correspond to the specifications in accordance with ISO 8655, Part 5. The test is to be carried out with these three testing volumes for testing of the systematic and random error in compliance with the standard. The smallest adjustable volume of 1 % serves to provide additional information.

8.5 Ambient conditions

Environment	For indoor use only. The surroundings must not be moist.
Ambient temperature	5 °C – 40 °C
Relative humidity	10 % – 95 %, non-condensing.
Atmospheric pressure	795 hPa – 1060 hPa

9 Transport, storage and disposal

9.1 Decontamination before shipment



CAUTION! Use of a contaminated device may result in personal injury and damage to the device.

- ▶ Clean and decontaminate the device in accordance with the cleaning instructions before shipping or storage.
-

Hazardous substances are:

- solutions presenting a health hazard
 - potentially infectious agents
 - organic solvents and reagents
 - radioactive substances
 - proteins presenting a health hazard
 - DNA
1. Please note the information in the "Decontamination certificate for product returns" document.
It is available as a PDF document on our website www.eppendorf.com/decontamination.
 2. Enter the serial number of the device on the decontamination certificate.
 3. Enclose the completed decontamination certificate for returned goods with the device.
 4. Send the device to Eppendorf AG or to an authorized service center.

9.2 Storage



NOTICE! Damage to device due to incorrect storage.

- ▶ Remove the rechargeable battery if you will not be using the device for an extended period (> 2 months).
- ▶ Remove the battery if you will not be using the device for an extended period (> 2 months).
- ▶ Do not store the device with the dispenser tip inserted.
- ▶ Select a secure storage location.
- ▶ Do not expose the device to aggressive gases over an extended period.



NOTICE! Damage due to UV radiation.

- ▶ Do not store consumables in areas with strong UV radiation.

	Air temperature	Relative humidity	Atmospheric pressure
In transport packing	-25 °C – 55 °C	10 % – 95 %	700 hPa – 1060 hPa
Without transport packing	-5 °C – 45 °C	10 % – 95 %	700 hPa – 1060 hPa

9.3 Disposal

Observe the relevant legal regulations when disposing of the product.

Information on the disposal of electrical and electronic devices in the European Community:

Within the European Community, the disposal of electrical devices is regulated by national regulations based on EU Directive 2012/19/EU pertaining to waste electrical and electronic equipment (WEEE).

According to these regulations, any devices supplied after August 13, 2005, in the business-to-business sphere, to which this product is assigned, may no longer be disposed of in municipal or domestic waste. They are marked with the following symbol to indicate this:



WARNING! Risk of explosion or fire due to overheated rechargeable batteries and batteries.

- ▶ Do not heat rechargeable batteries and other batteries to temperatures above 60 °C and do not throw them into a fire.

Do not dispose of batteries as household waste. Dispose of batteries in accordance with the local regulations.

As the disposal regulations may differ from one country to another within the EU, please contact your supplier for more information.

Ordering Information

Multipette® E3/E3x – Repeater® E3/E3x
English (EN)

10 Ordering Information

10.1 Dispenser Multipette E3/E3x – Repeater E3/E3x

Order no. (International)	Order no. (North America)	Description
4987 000.010	–	Multipette E3
4987 000.029	–	Multipette E3x
–	4987000118	Repeater E3
–	4987000134	Repeater E3x
4987 000.371	–	Multipette E3 bundle incl. charger stand
4987 000.380	–	Multipette E3x bundle incl. charger stand
–	4987000398	Repeater E3 bundle incl. charger stand
–	4987000410	Repeater E3x bundle incl. charger stand

10.2 Spare parts

Order no. (International)	Order no. (North America)	Description
4986 602.009	022462407	Li-ion rechargeable battery for Multipette/Repeater (X)stream, Multipette/ Repeater E3/E3x
4986 603.005	4986603005	Power supply with power plug adapters for pipettes and charger stand

10.3 Accessories for the dispenser

Order no. (International)	Order no. (North America)	Description
3116 000.040	3116000040	Charger Stand 2 for one electronic Eppendorf Multipette (Repeater)
3116 603.003	3116603003	Charger Shell 2 for one electronic Eppendorf Multipette (Repeater) for Charger Carousel 2 (with charging functionality)

Order no. (International)	Order no. (North America)	Description
3116 000.139	3116000139	Holder 2 for one electronic Eppendorf Multipette (Repeater) for Carousel 2, Charger Carousel 2 or wall mounting (without charging functionality)

10.4 Dispenser tip – Combitips advanced

10.4.1 Purity grade – Eppendorf Quality

Order no. (International)	Order no. (North America)	Description
0030 089.405	0030089405	Combitips advanced 0.1 mL 100 pieces Eppendorf Quality
0030 089.413	0030089413	Combitips advanced 0.2 mL 100 pieces Eppendorf Quality
0030 089.421	0030089421	Combitips advanced 0.5 mL 100 pieces Eppendorf Quality
0030 089.430	0030089430	Combitips advanced 1.0 mL 100 pieces Eppendorf Quality
0030 089.448	0030089448	Combitips advanced 2.5 mL 100 pieces Eppendorf Quality
0030 089.456	0030089456	Combitips advanced 5.0 mL 100 pieces Eppendorf Quality
0030 089.464	0030089464	Combitips advanced 10 mL 100 pieces Eppendorf Quality
0030 089.472	0030089472	Combitips advanced 25 mL 100 pieces + 4 Adapter Eppendorf Quality
0030 089.480	0030089480	Combitips advanced 50 mL 100 pieces + 4 Adapter Eppendorf Quality

10.4.2 Purity grade – Sterile

Order no. (International)	Order no. (North America)	Description
–	0030089510	Combitips advanced 0.1 mL 100 pieces Sterile, individually wrapped
–	0030089529	Combitips advanced 0.2 mL 100 pieces Sterile, individually wrapped
–	0030089537	Combitips advanced 0.5 mL 100 pieces Sterile, individually wrapped
–	0030089545	Combitips advanced 1.0 mL 100 pieces Sterile, individually wrapped
–	0030089553	Combitips advanced 2.5 mL 100 pieces Sterile, individually wrapped
–	0030089561	Combitips advanced 5.0 mL 100 pieces Sterile, individually wrapped
–	0030089570	Combitips advanced 10 mL 100 pieces Sterile, individually wrapped
–	0030089588	Combitips advanced 25 mL 100 pieces + 4 Adapter Sterile, individually wrapped
–	0030089596	Combitips advanced 50 mL 100 pieces + 4 Adapter Sterile, individually wrapped

10.4.3 Purity grade – Biopur

Order no. (International)	Order no. (North America)	Description
0030 089.618	0030089618	Combitips advanced 0.1 mL 100 pieces Biopur, individually wrapped
0030 089.626	0030089626	Combitips advanced 0.2 mL 100 pieces Biopur, individually wrapped
0030 089.634	0030089634	Combitips advanced 0.5 mL 100 pieces Biopur, individually wrapped
0030 089.642	0030089642	Combitips advanced 1.0 mL 100 pieces Biopur, individually wrapped
0030 089.650	0030089650	Combitips advanced 2.5 mL 100 pieces Biopur, individually wrapped
0030 089.669	0030089669	Combitips advanced 5.0 mL 100 pieces Biopur, individually wrapped
0030 089.677	0030089677	Combitips advanced 10 mL 100 pieces Biopur, individually wrapped
0030 089.685	0030089685	Combitips advanced 25 mL 100 pieces + 4 Adapter Biopur, individually wrapped
0030 089.693	0030089693	Combitips advanced 50 mL 100 pieces + 4 Adapter Biopur, individually wrapped

Ordering Information

Multipette® E3/E3x – Repeater® E3/E3x
English (EN)

10.4.4 Purity grade – PCR clean

Order no. (International)	Order no. (North America)	Description
0030 089.766	–	Combitips advanced 0.1 mL 100 pieces PCR clean
0030 089.774	–	Combitips advanced 0.2 mL 100 pieces PCR clean
0030 089.782	–	Combitips advanced 0.5 mL 100 pieces PCR clean
0030 089.790	–	Combitips advanced 1.0 mL 100 pieces PCR clean
0030 089.804	–	Combitips advanced 2.5 mL 100 pieces PCR clean
0030 089.812	–	Combitips advanced 5.0 mL 100 pieces PCR clean
0030 089.820	–	Combitips advanced 10 mL 100 pieces PCR clean
0030 089.839	–	Combitips advanced 25 mL 100 pieces + 4 Adapter PCR clean
0030 089.847	–	Combitips advanced 50 mL 100 pieces + 4 Adapter PCR clean

10.4.5 Purity grade – Forensic DNA Grade

Order no. (International)	Order no. (North America)	Description
0030 089.855	0030089855	Combitips advanced 1.0 mL 100 pieces Forensic DNA Grade, individually wrapped
0030 089.863	0030089863	Combitips advanced 2.5 mL 100 pieces Forensic DNA Grade, individually wrapped
0030 089.871	0030089871	Combitips advanced 5.0 mL 100 pieces Forensic DNA Grade, individually wrapped

10.4.6 Adapter advanced for dispenser tip

Order no. (International)	Order no. (North America)	Description
0030 089.715	0030089715	Adapter advanced 25 mL 1 piece Eppendorf Quality
0030 089.723	0030089723	Adapter advanced 50 mL 1 piece Eppendorf Quality
0030 089.731	0030089731	Adapter advanced 25 mL 7 pieces Biopur, individually wrapped
0030 089.740	0030089740	Adapter advanced 50 mL 7 pieces Biopur, individually wrapped

Ordering Information

Multipette® E3/E3x – Repeater® E3/E3x
English (EN)

10.5 Dispenser tip – ViscoTip**10.5.1 Purity grade – Eppendorf Quality**

Order no. (International)	Order no. (North America)	Description
0030 089.502	0030089502	ViscoTip 10 mL 100 pieces Eppendorf Quality

10.6 Accessories for Combitips advanced

Order no. (International)	Order no. (North America)	Description
0030 089.758	0030089758	Combitips advanced Rack 1 piece Eppendorf Quality, for 8 dispenser tips (0.1 – 10 mL)

Index

A

Accessing *Favorites* 43
 Adjust language..... 41
 Aspirating liquid 29

C

Carrying out a reverse stroke 29
 Change Parameter 28
 Charger carousel
 Charging the rechargeable battery .. 25
 Charging stand
 Charging the rechargeable battery .. 25
 Charging status
 Rechargeable battery 17
 Charging the rechargeable battery 24
 Cleaning 47
 Color code
 Color code 19
 Color identification
 Volumes..... 19
 Combitip
 Color code 19
 Connecting the rechargeable battery 23

D

Device settings 38
 Disinfection 47
 Display 15
 Display layout 15
 Disposal 55

E

Editing *Favorites* 44
 Ejecting the dispenser tip..... 28
 Emptying the dispensing tip 38
 Errors of measurement..... 51

F

Features..... 13

I

Initial use.....20
 Inserting the dispenser tip27

M

Mains/power supply device 17
 Charging the rechargeable battery ...24
 Mains/power supply device assembly21
 Materials 18

O

Operating control
 Actuate key..... 16
 Ejector 16
 Reset 16
 Rocker 16
 Selection dial..... 16
 Softkey 16

Operating mode

A/D 35
Ads 32
Asp 34
Dis 31
Opt 38
Pip 30
Seq 33
Ttr 36

Operating modes

E3 16
 E3x 16

Option

Key lock 40
Language 41
Personalization 42
Screen saver..... 43
Service 42

Option

Date and time 43

Overview of parameters 28

P

Parameter set
 Favorites 43
Power plug adapter 17

R

Renewed aspiration 37

S

Service function
 Reminder 42
 Self test 42
Storage 54

T

Technical data
 Ambient conditions 52
Troubleshooting
 Dispenser 45
 Dispenser tip 46
 Display 45
 Rechargeable battery 45

V

ViscoTip
 Color code 19

W

Warranty 18

Eppendorf Certificate

Declaration of Conformity – China RoHS 2 for Multipette® E3/E3x and Repeater® E3/E3x

Eppendorf AG has made reasonable efforts to ensure that hazardous materials and substances may not be used in the Multipette® E3/E3x and Repeater® E3/E3x.

In order to determine the concentration of hazardous substances in all homogeneous materials of the subassemblies, a "Product Conformity Assessment" (PCA) procedure was performed. As defined in GB/T 26572 the "Maximum Concentration Value" limits (MCV) apply to these restricted substances:

- Lead (Pb): 0.1%
- Mercury (Hg): 0.1%
- Cadmium (Cd): 0.01%
- Hexavalent Chromium (Cr(+VI)): 0.1%
- Polybrominated Biphenyls (PBB): 0.1%
- Polybrominated Diphenyl Ethers (PBDE): 0.1%

Environmental Friendly Use Period (EFUP)

EFUP defines the period in years during which the hazardous substances contained in electrical and electronic products will not leak or mutate under normal operating conditions. During normal use by the user such electrical and electronic products will not cause serious environmental pollution, serious bodily injury or damage to the user's assets.

The Environmental Friendly Use Period for Multipette® E3/E3x and Repeater® E3/E3x is 20 years.



Products manufactured by Eppendorf may become components of other devices or can be used with other appliances. With these third-party products and devices in particular, please note the EFUP labeled on these products. Eppendorf will not take responsibility for the EFUP of those products and devices.

Eppendorf Certificate

此表格是按照 SJ/T 11364-2014 中规定所制定的。
This table is created according to SJ/T 11364-2014.

MATERIAL CONTENT DECLARATION (产品中有有害物质名称和含量表)						
有害物质 / Hazardous Substances						
部件名称 Part Name	铅 Pb	汞 Hg	镉 Cd	六价铬 Cr(+VI)	多溴联苯 PBB	多溴二苯醚 PBDE
驱动轴 / Drive Shaft	X	O	O	O	O	O
充电接触 / Charging Contact	X	O	O	O	O	O
马达 / Motor	X	O	O	O	O	O

O: 表示该有毒有害物质在该部件所有均质材料中的含量均在GB/T 26572规定的限量要求以下。

O: Indicates that the above mentioned hazardous substance contained in all homogeneous materials of the part is below the required limit as defined in GB/T 26572.

X: 表示该有毒有害物质至少在该部件某一均质材料中的含量超出GB/T 26572规定的限量要求。

X: Indicates that the above mentioned hazardous substance contained in at least one of the homogeneous materials of this part is above the required limit as defined in GB/T 26572.

除上表所示信息外，还需声明的是，这些部件并非有意用铅 (Pb)、汞 (Hg)、镉 (Cd)、六价铬 (Cr(+VI))、多溴联苯 (PBB) 或多溴二苯醚 (PBDE) 来制造的。

Apart from the disclosures in the above table, the subassemblies are not intentionally manufactured or formulated with Lead (Pb), Mercury (Hg), Cadmium (Cd), hexavalent Chromium (Cr(+VI)), polybrominated Biphenyls (PBB), and polybrominated Diphenyl Ethers (PBDE).

Date: Hamburg, April 29, 2019

Page 2 of 2

Dr. B. Schreiber
Vice President Quality Management
& Regulatory Affairs

Dipl. Wirt.-Ing. C. Markau
Business Manager
Manual Liquid Handling

Your local distributor: www.eppendorf.com/contact
Eppendorf AG · Barkhausenweg 1 · 22339 Hamburg · Germany
E-mail: eppendorf@eppendorf.com

ISO 9001
Certified

ISO 13485
Certified

ISO 14001
Certified

Eppendorf®, the Eppendorf Brand Design, MultiPipette® and Repipator® are registered trademarks of Eppendorf AG.
All rights reserved, incl. graphics and images. Copyright ©2019 by Eppendorf AG.

Declaration of Conformity

The product named below fulfills the requirements of directives and standards listed. In the case of unauthorized modifications to the product or an unintended use this declaration becomes invalid. This declaration of conformity is issued under the sole responsibility of the manufacturer.

Product name:

Multipette® E3/E3x

Product type:

Electronically controlled manual dispenser

Relevant directives / standards:

2014/35/EU: EN 62368-1 + AC

2014/30/EU: EN 61326-1, EN 55011

2011/65/EU: EN IEC 63000

Further applied standards: EN ISO 8655-1 + AC, EN ISO 8655-5 + AC, EN ISO 8655-6 + AC

Hamburg, March 09, 2021



Dr. Wilhelm Plüster
Management Board



Dr. Christian Eggert
Head of Division
Liquid Handling

Your local distributor: www.eppendorf.com/contact
Eppendorf AG · Barkhausenweg 1 · 22339 Hamburg · Germany
eppendorf@eppendorf.com

ISO
9001
Certified

ISO 13485
Certified

ISO 14001
Certified

Eppendorf®, the Eppendorf Brand Design and Multipette® are registered trademarks of Eppendorf AG, Germany.
U.S. Design Patents are listed on www.eppendorf.com/ip.
All rights reserved, incl. graphics and images. Copyright ©2021 by Eppendorf AG.



Evaluate Your Manual

Give us your feedback.
www.eppendorf.com/manualfeedback

Your local distributor: www.eppendorf.com/contact
Eppendorf SE · Barkhausenweg 1 · 22339 Hamburg · Germany
eppendorf@eppendorf.com · www.eppendorf.com